



PRODUKTLISTA 2022
AVK SVERIGE AB

Expect... **AVR**



AVK

MEDARBETARE I SVERIGE

WWW.AVKVALVES.SE

AVK Sverige AB

Växthusvägen 5
281 51 Hässleholm
Växel: 0451 458 00
E-post: sales@avkvalves.se



Vatten



Avlopp



Gas



Brand



Mikael Storm
Försäljningschef

Tfn: 0724 02 19 74
E-post: mist@avkvalves.se



Sofia Hansson
Administration - Ekonomi

Tfn: 0451 423 46
E-post: sofhan@avkvalves.se



Gimmy Larsson
Marknadsassistent

Tfn: 0451 458 00
E-post: gimmlar@avkvalves.se



Johan Eldonson
Innesälj / Teknisk support

Tfn: 0451 458 00
E-post: joel@avkvalves.se



Thomas Lantz
Innesälj / Marknad

Tfn: 0451 458 00
E-post: thla@avkvalves.se



Finn Svensson
Innesälj / Logistik

Tfn: 0451 458 00
E-post: fsve@avkvalves.se



Johan Malm
Lager / Logistik



Ulf Nielsen
Lager / Logistik



Eddie Holmqvist
Affärsutvecklare
Tfn: 0451 458 00
Mobil: 0704 71 10 06
E-post: eht@avkvalves.se



Mikael Nyberg
Distriktsansvarig säljare nord
Mobil: 0703 89 96 77
Epost: miny@avkvalves.se



Fredrik Tholén
Distriktsansvarig säljare väst
Mobil: 0702 16 88 59
E-post: fret@avkvalves.se





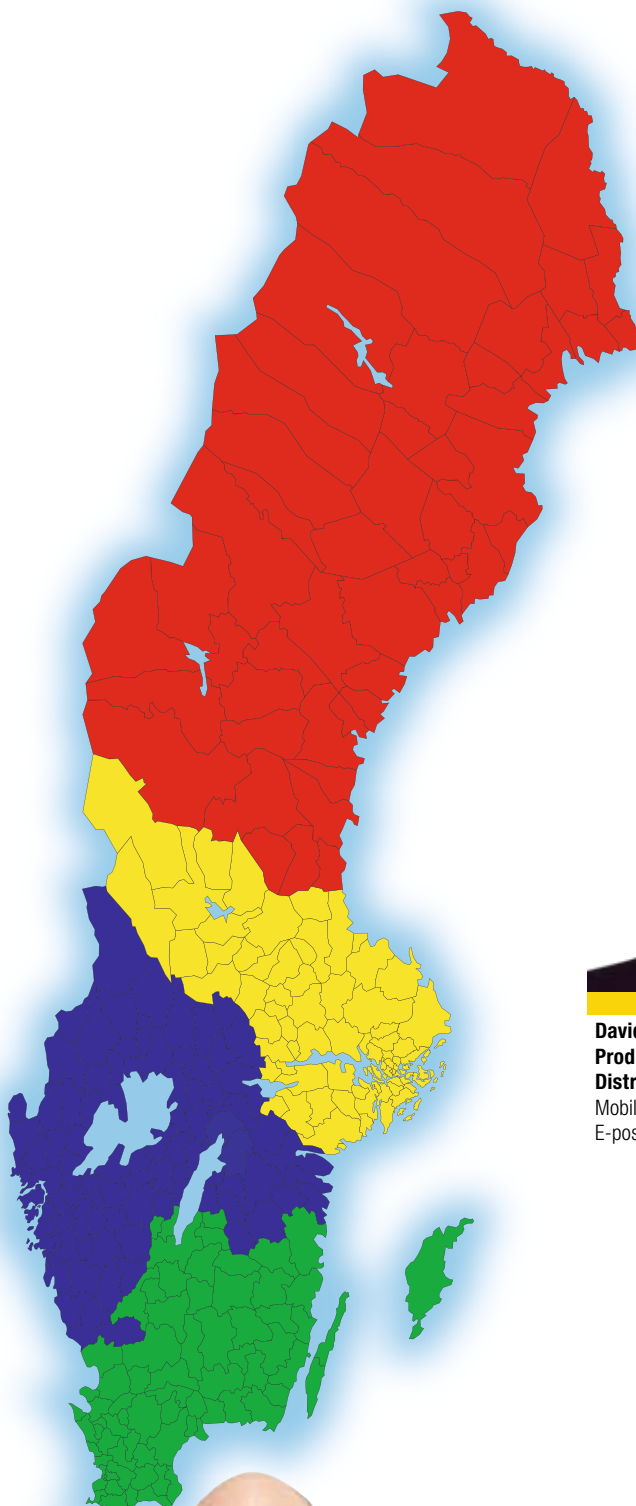









































































David Sjöcrona
Produktchef vatten i Sverige
Distriktsansvarig säljare öst
Mobil: 0705 80 11 02
E-post: dsj@avkvalves.se



Mattias Holgersson
Produktchef brand i Sverige
Distriktsansvarig säljare syd
Mobil: 0733 77 91 77
E-post: maho@avkvalves.se

INNEHÅLLSFÖRTECKNING

											
	Servisventiler av segjärn	12			Dubbelexcentriska vridspjällsventiler	30			Servisventiler med NBR-gummi	43	
	Servisventiler av mässing	14			Garnityr till vridspjäll 756	31			Slussventiler med PE-rör	44	
	Servisventiler av POM	15			Centriska vridspjällsventiler	32			Slussventiler med fläns	44	
	Garnityr till servisventiler	17			Flänspackningar med stål kärna	33			Slussventiler förberedda för manöverdon	45	
	Slussventiler med PE-rör	20			Betäckningar av segjärn	34			Slussventiler med pneumatiska manöverdon	45	
	Slussventiler med fläns	24			Betäckningar av komposit	34			Backventiler med klaff	46	
	Slussventiler förberedda för manöverdon	26			Garnityrstöd, låsbygel, plomberingsbricka	35			Backventiler med kula	47	
	Slussventiler med Supa maxi kopplingar	25			T-nyckel, spindelshylsa, saxpinnar, nyckelshylsa, handdratt	35			Skjutspjällsventiler	48	
	Slussventiler för huvudledning	26			Brandposter	36			Slussluckor	49	
	Kombiventiler	28			Tillbehör till brandposter	39			Avluftningsventiler	50	
	Garnityr till slussventiler DN 50-600	29			Avluftningsventiler	40					
					Klaffbackventiler och tillbehör	42					

										
	Slussventiler med fläns	51			Flänsad ventil med lägesvisare	54			Stödhylsor i rostfritt stål	55
	Slussventiler med PE-rör	51			Flänsad ventil med stigande spindel	54			Kombiflänsar	56
	Servisventiler	51			Vridspjällsventiler	54			Supa Plus™ kopplingar och adaptrar	57
	Flänspackningar med stålkärna	52			Slussventil med rilländar	54			Universala AVK Flex kopplingar och adaptrar	58
	Kulventiler för gas	53							Montageboxar	59
	Garnityr till kulventiler	53							Supa Maxi™	60
	Betäckningar i plast	53							Supa Lock™ System	64
									Dimensionering av teleskopgarnityr	68
									YD vattenledningsrör	70
									Teknisk information	72
									Gummi specifikationer	74
									Certifikat	76

Vi reserverar oss för tryckfel och rättigheter till tekniska ändringar förbehålles AVK Sverige AB

SUPA MAXI™ DRAGFASTA UNIVERSALA KOPPLINGAR UPP TILL DN 600



AVK har utökat dimensions-området med kopplingar, flänsadapter och ändhuv till DN 600.

Designen för den nya DN 400 är densamma som för de befintliga dimensionerna. Den mest betydande fördelen gentemot de andra kopplingarna på marknaden är det patenterade SupaGrip™ tätningssystemet.

SupaGrip™ består av flexibla klämdelar som vid åtdragning drar ihop sig, så att de följer den yttre rördiametern. Det säkerställer maximalt stöd för pakningen, så att den tätar 100% runt röret även på minimi rörstorlek eller ovalt rör.

Supa Maxi™ fördelar:

- Universal och dragfast på alla rörtyper
- Snabb utväxling vid åtdragning av kopplingen
- Supa Grip™ tätningssystem
- $\pm 4^\circ$ avvinkling på vardera sida
- Stora toleranser på insticksdjup
- Ingen efterdragning av bultar
- Lyftögla på DN 100-600
- Permanenta skyddskåpor med lock
- Godkänd för dricksvatten med EPDM packning
- GSK godkänd, Epoxy enl. 30677-2

Innan åtdragning



Efter åtdragning



Locket i centrum tas bort vid montage



AVK SLUSSVENTIL MED DRAGFASTA SUPA MAXI™ KOPPLINGAR



AVK slussventil med Supa Maxi™ kopplingar är en universell dragfast koppling med inbyggd ventil, vilket ger extra säkerhet för reparation av gamla ledningar.

När ni använder Supamaxi Maxi™ slussventil för reparation av gamla rör är det lätt att stänga av vattnet vid ytterligare reparationer eller utbyte av det gamla röret vid ett senare tillfälle.

Ventilen har AVK's välkända design med en unik kil som har en fast kilmutter och AVK egna dricksvattengodkända EPDM-gummi. Supa Maxi™ kopplingsändarna kännetecknas av en mycket robust konstruktion, enkel installation och SupaGrip™ tätningssystem för maximal tätning.

FÖRVÄNTA UNIKA PRODUKTER



AVK är en global ledare inom ventiler, brandposter, rördelar och tillbehör för vattenförsörjning, gas, avloppsrening och brandskydd.

AVK har moderna produktionsanläggningar och ett stort distributionsnät som gör att vi kan leverera snabbt och effektivt.

Ett komplett sortiment, snabba leveranser, överlägsen kvalitet, konkurrenskraftiga priser och den högsta servicen är några av de fördelar du ska förvänta dig från AVK.

Produktutveckling

Marknadens närhet är en viktig del av AVK's strategi. Nära kontakt med slutanvändaren säkerställer en noggrann övervakning av marknaden och ständig anpassning och utveckling av produktprogrammet för att möta marknadens krav. Detta görs på vår utvecklingsavdelning i Danmark, ett avancerat tekniskt center, där idéer och förslag från olika länder samlas. Befintliga produkter anpassas och testas kontinuerligt i samarbete med slutanvändaren. Produkterna testas därefter på fältet innan den slutliga marknaden tar del av dem och därmed åstadkomms det bästa resultatet på varje enskild marknad.

Produktion

Produktionen sker i flera länder i Europa och Asien samt i USA och Saudi Arabien. AVK's produkter tillverkas också på licens i flera

andra länder. Lagerstyrning och distribution till slutanvändare hanteras genom ett brett nätverk av företag, agenter och återförsäljare i mer än 85 länder. Detta nätverk ger AVK viktig information om förändringar på marknaden och håller sig därmed uppdaterade på kundernas krav och behov.

Kvalitet

AVK's produkter kännetecknas av en hög och jämn kvalitet med konkurrenskraftiga priser och hållbarhet. Detta kräver en strikt kvalitetskontroll av produktionens processer från början till slut. Därmed har AVK certifierats enligt ISO 9001. Dessutom är vi certifierade enligt ISO 14001, den internationella standarden för miljöledning och OHSAS 18001, som är den internationella standarden för Yrkessäkerhet och hälsan i arbetet.

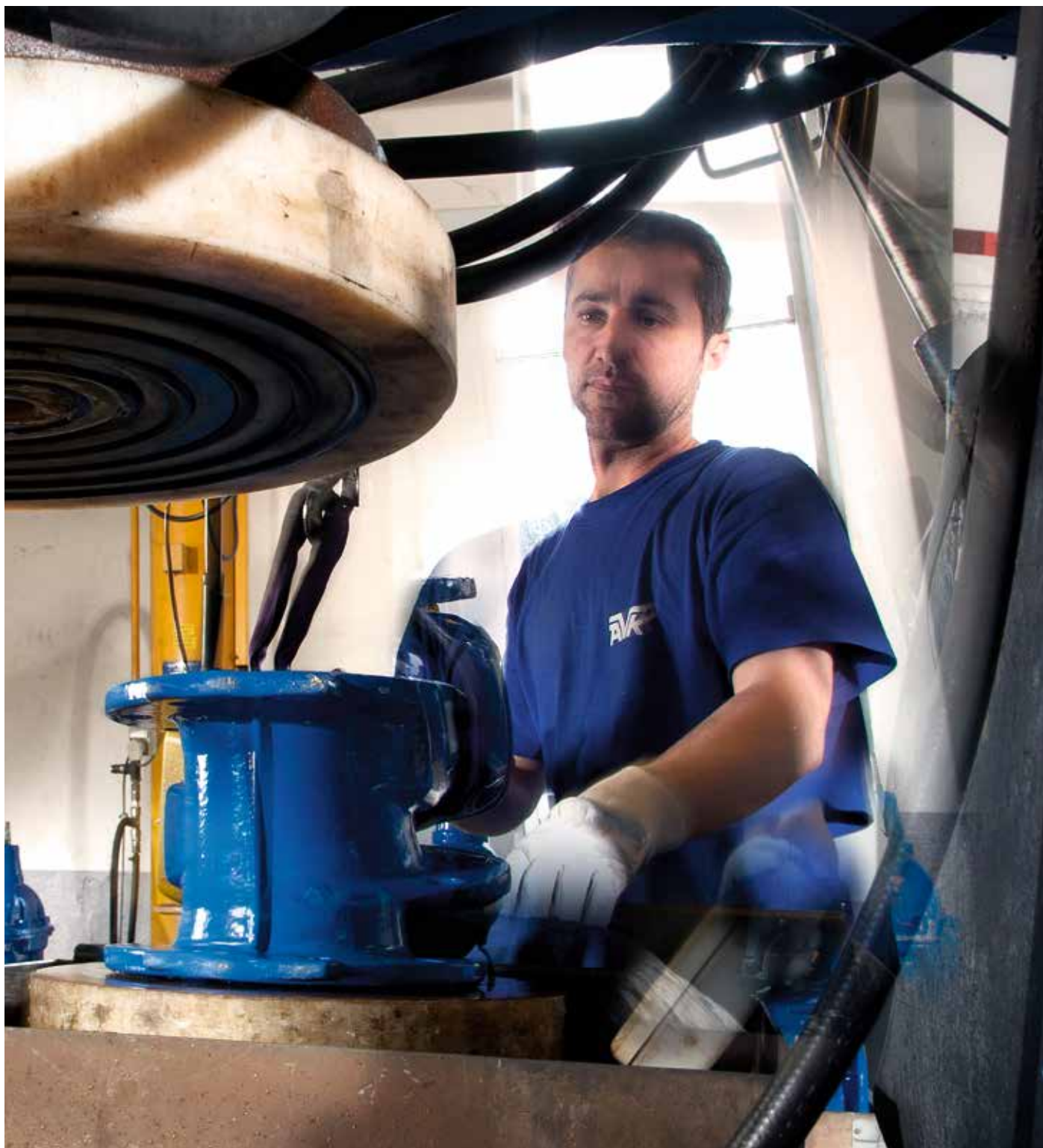

AVK fokuserar på miljön

AVK's produkter är en del av infrastrukturen, vilket spelar en viktig roll för den lokala miljön över hela världen. AVK fokuserar även på miljön i alla sina interna processer. AVK Koncernen har skissat ett antal strikta mål för sina tillverkande företag för energi och vattenförbrukning. Våra leverantörer måste följa ett antal standarder för att vara en certifierad leverantör till AVK-gruppen, detta är avgörande för att AVK ska kunna uppnå kvalite i hela leverantörkedjan.

Segment:



Vattenförsörjning

Slussventiler och tillbehör, vridspjäll, backventiler, luftventiler, brandposter. Kopplingar, rördelar etc.



Gasförsörjning

Slussventiler och tillbehör, backventiler, kopplingar och reparation klämmor.



Avloppsrening

Slussventiler, Skjutspjällsventiler, backventiler, vridspjällsventiler, luftventiler, dammluckor etc.



Brandskydd

Brandposter, Slussventiler, vridspjällsventiler etc.

AVK ÄR SYSTEMLEVERANTÖR



Tryckavloppssystem



INGA KOMPROMISSER

Doppmålning upp till DN400



Tre oberoende tätningssystem.

- En Manschett (1) är den huvudsakliga tätningen mot flödet.
- Fyra NBR O-ringar i ett lager av polyamid (2) ger täthet runt spindeln. Alternativt en spindeltätningssmutter av mässing (3) som kan bytas ut under tryck.
- En NBR avstrykarring (4) skyddar mot föroreningar från utsidan.

Spindelmuttern (5) i avzinkningsbeständig mässing (lågbley) ger ett lågt vridmoment.

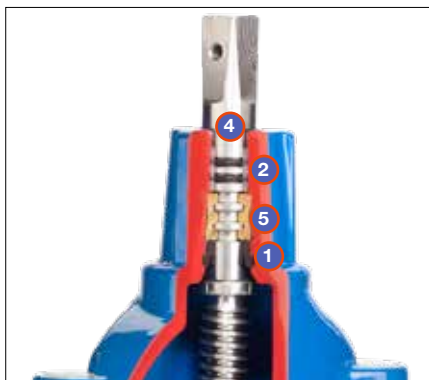

Spindeltätning med polyamidlager
- för vatten och avlopp.

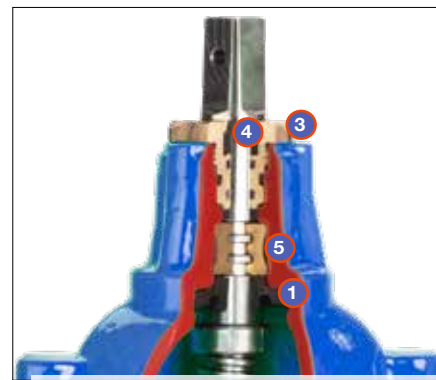

Utbyttbar spindeltätning av mässing och
spindelmuttern av mässing
- för vatten och gas.

Våra slussventiler i DN 450-600 och 800 är utformade med två rullager (6) och en spindelmuttern av rostfritt stål som erbjuder låga vridmoment.

Tät montering av ventilhus och överdel

En rund packning passar in i ett spår mellan ventilhuset och överdelen, vilket förhindrar den från att pressas ut vid tryckstötter. De rostfria bultarna (7) är omgivna av packningen och försänkta i överdelen och slutligen förseglade med smältlim för att förhindra korrosion.

100 % trycktestade

Varje ventil trycktestas innan den lämnar fabriken. Gasventiler testas enligt DIN 3230-5, PG 3 / EN 13774 klass 2 och vattenventiler enligt EN 1074-1 och 2 / EN 12266.

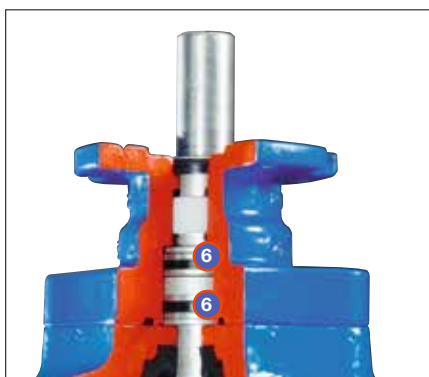

Serie 06 DN 450-600 och 800
- rullager för låga vridmoment.



Den försänkta packningen omsluter bultarna
som fäster överdelen mot ventilhuset.



SERVISVENTILER AV SEGJÄRN

Ventilerna har dricksvattengodkänt EPDM-gummi
Elektrostatiskt applicerad epoxi-beläggning enligt DIN
30677-2 och GSK riktlinjer

Kan fås med klämringsskoppling, instickskoppling, PRK-
mutter eller med PE-ändar

Dricksvattengodkända av KIWA

Serie 03/90-005

Servisventil
med dragfasta PRK-
kopplingar för PE-rör
Segjärn
Epoxibeläggning in- och
utvändigt
PN 16
DN 20-50



AVK nr.	RSK nr.	DN	PE-rör	PN	Vikt	St/pall	Kod
03-025-90-0046499	4303103	20	25	16	3,2	64	B
03-032-90-0046499	4303111	25	32	16	2,95	65	A
03-040-90-0046499	4303129	32	40	16	3,1	58	A
03-050-90-00	4303137	40	50	16	6,5	41	A
03-063-90-00	4303145	50	63	16	6,1	32	A

Serie 03/93-005

Servisventil med dragfasta
PRK-kopplingar för PE-rör
Segjärn
Emaljbelagd invändigt
Epoxibeläggning utvändigt
PN 16
DN25-32



AVK nr.	RSK nr.	DN	PE-rör	PN	Vikt	St/pall	Kod
03-032-93-0046499	4303147	25	32	16	2,95	80	B
03-040-93-0046499	4303148	32	40	16	3,1	60	B
03-050-93-001	4303149	40	50	16	5,2	50	B
03-063-93-001	4303150	50	63	16	6,4	40	B

Serie 03/00-010

Servisventil med invändig
gånga
Segjärn
Epoxibeläggning in- och
utvändigt
PN 16
DN 25-50



AVK nr.	RSK nr.	DN	BSP	PN	Vikt	St/pall	Kod
03-025-00-0046499	4255425	20	¾"	16	2,8	96	A
03-032-00-0046499	4301974	25	1"	16	2,8	96	A
03-040-00-0046499	4301982	32	1¼"	16	3,3	88	A
03-050-00-001	4301990	40	1½"	16	4,7	55	A
03-063-00-001	4302006	50	2"	16	6,4	48	A

Serie 03/30-005

Servisventil med dragfasta
insticksmuffar för PE-rör
Segjärn
Epoxibeläggning in- och
utvändigt
PN 16
DN 20-50



AVK nr.	RSK nr.	DN	PE-rör	PN	Vikt	St/pall	Kod
03-025-30-0046499	4255426	20	25	16	3,2	70	A
03-032-30-0046499	4302063	25	32	16	3,5	64	A
03-040-30-0046499	4302071	32	40	16	4	58	A
03-050-30-00	4302089	40	50	16	7	36	A
03-063-30-00	4302097	50	63	16	8,5	27	A







Serie 03/34-001

Servisventil med dragfasta
insticksmuffar för PE-rör
Segjärn
Duplex spindel 1.4362
Epoxibeläggning in- och
utvändigt
PN 16
DN 25-50



NYHET

AVK nr.	RSK nr.	DN	PE-rör	PN	Vikt	St/pall	Kod
03-032-34-0046499	4328557	25	32	16	3,5	64	C
03-040-34-0046499	4328558	32	40	16	4	58	C
03-050-34-00464	4328559	40	50	16	7	36	C
03-063-34-00464	4328560	50	63	16	8,5	27	C

<p>Serie 03/65-005 Servisventil med dragfasta skruvkopplingar för PE-rör Segjärn Epoxibeläggning in- och utvändigt PN 16 DN 25-50</p> 	<table border="1"> <thead> <tr> <th>AVK nr.</th> <th>RSK nr.</th> <th>DN</th> <th>PE-rör</th> <th>PN</th> <th>Vikt</th> <th>St/pall</th> <th>Kod</th> </tr> </thead> <tbody> <tr> <td>03-032-65-0046499</td> <td>4302072</td> <td>25</td> <td>32</td> <td>16</td> <td>3,1</td> <td>70</td> <td>C</td> </tr> <tr> <td>03-040-65-0046499</td> <td>4302073</td> <td>32</td> <td>40</td> <td>16</td> <td>3,7</td> <td>64</td> <td>C</td> </tr> <tr> <td>03-050-65-001</td> <td>4302074</td> <td>40</td> <td>50</td> <td>16</td> <td>5,8</td> <td>41</td> <td>C</td> </tr> <tr> <td>03-063-65-001</td> <td>4302075</td> <td>50</td> <td>63</td> <td>16</td> <td>7,2</td> <td>36</td> <td>C</td> </tr> </tbody> </table>	AVK nr.	RSK nr.	DN	PE-rör	PN	Vikt	St/pall	Kod	03-032-65-0046499	4302072	25	32	16	3,1	70	C	03-040-65-0046499	4302073	32	40	16	3,7	64	C	03-050-65-001	4302074	40	50	16	5,8	41	C	03-063-65-001	4302075	50	63	16	7,2	36	C					
AVK nr.	RSK nr.	DN	PE-rör	PN	Vikt	St/pall	Kod																																							
03-032-65-0046499	4302072	25	32	16	3,1	70	C																																							
03-040-65-0046499	4302073	32	40	16	3,7	64	C																																							
03-050-65-001	4302074	40	50	16	5,8	41	C																																							
03-063-65-001	4302075	50	63	16	7,2	36	C																																							
<p>Serie 03/85-005 Servisventil med utvändigt gänga/dragfast skruvkoppling för PE-rör Segjärn Epoxibeläggning in- och utvändigt PN 16 DN 25-32</p> 	<table border="1"> <thead> <tr> <th>AVK nr.</th> <th>RSK nr.</th> <th>DN</th> <th>PE-rör</th> <th>BSP</th> <th>PN</th> <th>Vikt</th> <th>St/pall</th> <th>Kod</th> </tr> </thead> <tbody> <tr> <td>03-032-83-0046499</td> <td>4302077</td> <td>25</td> <td>32</td> <td>1¼"</td> <td>16</td> <td>3</td> <td>71</td> <td>C</td> </tr> <tr> <td>03-032-85-0046499</td> <td>4302076</td> <td>25</td> <td>32</td> <td>1"</td> <td>16</td> <td>2,95</td> <td>70</td> <td>C</td> </tr> <tr> <td>03-040-84-001</td> <td>4302078</td> <td>32</td> <td>40</td> <td>1"</td> <td>16</td> <td>3,3</td> <td>70</td> <td>C</td> </tr> <tr> <td>03-040-85-001</td> <td>4302079</td> <td>32</td> <td>40</td> <td>1¼"</td> <td>16</td> <td>3,1</td> <td>70</td> <td>C</td> </tr> </tbody> </table>	AVK nr.	RSK nr.	DN	PE-rör	BSP	PN	Vikt	St/pall	Kod	03-032-83-0046499	4302077	25	32	1¼"	16	3	71	C	03-032-85-0046499	4302076	25	32	1"	16	2,95	70	C	03-040-84-001	4302078	32	40	1"	16	3,3	70	C	03-040-85-001	4302079	32	40	1¼"	16	3,1	70	C
AVK nr.	RSK nr.	DN	PE-rör	BSP	PN	Vikt	St/pall	Kod																																						
03-032-83-0046499	4302077	25	32	1¼"	16	3	71	C																																						
03-032-85-0046499	4302076	25	32	1"	16	2,95	70	C																																						
03-040-84-001	4302078	32	40	1"	16	3,3	70	C																																						
03-040-85-001	4302079	32	40	1¼"	16	3,1	70	C																																						
<p>Serie 36/8X-116 Servisventil för direkt sammansvetsning med PE-rör Segjärn Epoxibeläggning in- och utvändigt PN 16 DN 25-50</p> 	<table border="1"> <thead> <tr> <th>AVK nr.</th> <th>RSK nr.</th> <th>DN</th> <th>PE-rör</th> <th>PN</th> <th>Vikt</th> <th>St/pall</th> <th>Kod</th> </tr> </thead> <tbody> <tr> <td>36-032-80-16306499</td> <td>4255205</td> <td>25</td> <td>32</td> <td>16</td> <td>5,1</td> <td>18</td> <td>A</td> </tr> <tr> <td>36-040-80-16306499</td> <td>4255206</td> <td>32</td> <td>40</td> <td>16</td> <td>5,5</td> <td>14</td> <td>A</td> </tr> <tr> <td>36-050-80-163</td> <td>4255207</td> <td>40</td> <td>50</td> <td>16</td> <td>5,6</td> <td>12</td> <td>A</td> </tr> <tr> <td>36-063-80-163</td> <td>4255208</td> <td>50</td> <td>63</td> <td>16</td> <td>6,8</td> <td>9</td> <td>A</td> </tr> </tbody> </table>	AVK nr.	RSK nr.	DN	PE-rör	PN	Vikt	St/pall	Kod	36-032-80-16306499	4255205	25	32	16	5,1	18	A	36-040-80-16306499	4255206	32	40	16	5,5	14	A	36-050-80-163	4255207	40	50	16	5,6	12	A	36-063-80-163	4255208	50	63	16	6,8	9	A					
AVK nr.	RSK nr.	DN	PE-rör	PN	Vikt	St/pall	Kod																																							
36-032-80-16306499	4255205	25	32	16	5,1	18	A																																							
36-040-80-16306499	4255206	32	40	16	5,5	14	A																																							
36-050-80-163	4255207	40	50	16	5,6	12	A																																							
36-063-80-163	4255208	50	63	16	6,8	9	A																																							
<p>Serie 36/79-016 Servisventil för direkt sammansvetsning med PE-rör Segjärn Duplex spindel 1.4362 Epoxibeläggning in- och utvändigt PN 16 DN 25-50</p> 	<table border="1"> <thead> <tr> <th>AVK nr.</th> <th>RSK nr.</th> <th>DN</th> <th>PE-rör</th> <th>PN</th> <th>Vikt</th> <th>St/pall</th> <th>Kod</th> </tr> </thead> <tbody> <tr> <td>36-032-79-16306499</td> <td>4296798</td> <td>25</td> <td>32</td> <td>16</td> <td>5,1</td> <td>18</td> <td>B</td> </tr> <tr> <td>36-040-79-16306499</td> <td>4296799</td> <td>32</td> <td>40</td> <td>16</td> <td>5,5</td> <td>14</td> <td>B</td> </tr> <tr> <td>36-050-79-163064</td> <td>4296800</td> <td>40</td> <td>50</td> <td>16</td> <td>9</td> <td>12</td> <td>B</td> </tr> <tr> <td>36-063-79-163064</td> <td>4296801</td> <td>50</td> <td>63</td> <td>16</td> <td>9</td> <td>9</td> <td>B</td> </tr> </tbody> </table>	AVK nr.	RSK nr.	DN	PE-rör	PN	Vikt	St/pall	Kod	36-032-79-16306499	4296798	25	32	16	5,1	18	B	36-040-79-16306499	4296799	32	40	16	5,5	14	B	36-050-79-163064	4296800	40	50	16	9	12	B	36-063-79-163064	4296801	50	63	16	9	9	B					
AVK nr.	RSK nr.	DN	PE-rör	PN	Vikt	St/pall	Kod																																							
36-032-79-16306499	4296798	25	32	16	5,1	18	B																																							
36-040-79-16306499	4296799	32	40	16	5,5	14	B																																							
36-050-79-163064	4296800	40	50	16	9	12	B																																							
36-063-79-163064	4296801	50	63	16	9	9	B																																							
<p>Serie 36/87-167 Servisventil för direkt sammansvetsning med PE-rör Segjärn Epoxibeläggning utvändigt Emaljbeldg invändigt PN 16 DN 25-50</p> 	<table border="1"> <thead> <tr> <th>AVK nr.</th> <th>RSK nr.</th> <th>DN</th> <th>PE-rör</th> <th>PN</th> <th>Vikt</th> <th>St/pall</th> <th>Kod</th> </tr> </thead> <tbody> <tr> <td>36-032-80-16706499</td> <td>4255213</td> <td>25</td> <td>32</td> <td>16</td> <td>5,1</td> <td>18</td> <td>B</td> </tr> <tr> <td>36-040-80-16706499</td> <td>4255214</td> <td>32</td> <td>40</td> <td>16</td> <td>5,5</td> <td>14</td> <td>B</td> </tr> <tr> <td>36-050-87-167</td> <td>4255215</td> <td>40</td> <td>50</td> <td>16</td> <td>9</td> <td>12</td> <td>B</td> </tr> <tr> <td>36-063-87-167</td> <td>4255216</td> <td>50</td> <td>63</td> <td>16</td> <td>9</td> <td>9</td> <td>B</td> </tr> </tbody> </table>	AVK nr.	RSK nr.	DN	PE-rör	PN	Vikt	St/pall	Kod	36-032-80-16706499	4255213	25	32	16	5,1	18	B	36-040-80-16706499	4255214	32	40	16	5,5	14	B	36-050-87-167	4255215	40	50	16	9	12	B	36-063-87-167	4255216	50	63	16	9	9	B					
AVK nr.	RSK nr.	DN	PE-rör	PN	Vikt	St/pall	Kod																																							
36-032-80-16706499	4255213	25	32	16	5,1	18	B																																							
36-040-80-16706499	4255214	32	40	16	5,5	14	B																																							
36-050-87-167	4255215	40	50	16	9	12	B																																							
36-063-87-167	4255216	50	63	16	9	9	B																																							
<p>Serie 36/79-087 Servisventil för direkt sammansvetsning med PE-rör Segjärn Duplex spindel 1.4362 Epoxibeläggning utvändigt Emaljbeldg invändigt PN 16 DN 25-50</p> 	<table border="1"> <thead> <tr> <th>AVK nr.</th> <th>RSK nr.</th> <th>DN</th> <th>PE-rör</th> <th>PN</th> <th>Vikt</th> <th>St/pall</th> <th>Kod</th> </tr> </thead> <tbody> <tr> <td>36-032-79-16706499</td> <td>4296802</td> <td>25</td> <td>32</td> <td>16</td> <td>5,1</td> <td>18</td> <td>B</td> </tr> <tr> <td>36-040-79-16706499</td> <td>4296803</td> <td>32</td> <td>40</td> <td>16</td> <td>5,5</td> <td>14</td> <td>B</td> </tr> <tr> <td>36-050-79-167064</td> <td>4296804</td> <td>40</td> <td>50</td> <td>16</td> <td>9</td> <td>12</td> <td>B</td> </tr> <tr> <td>36-063-79-167064</td> <td>4296805</td> <td>50</td> <td>63</td> <td>16</td> <td>9</td> <td>9</td> <td>B</td> </tr> </tbody> </table>	AVK nr.	RSK nr.	DN	PE-rör	PN	Vikt	St/pall	Kod	36-032-79-16706499	4296802	25	32	16	5,1	18	B	36-040-79-16706499	4296803	32	40	16	5,5	14	B	36-050-79-167064	4296804	40	50	16	9	12	B	36-063-79-167064	4296805	50	63	16	9	9	B					
AVK nr.	RSK nr.	DN	PE-rör	PN	Vikt	St/pall	Kod																																							
36-032-79-16706499	4296802	25	32	16	5,1	18	B																																							
36-040-79-16706499	4296803	32	40	16	5,5	14	B																																							
36-050-79-167064	4296804	40	50	16	9	12	B																																							
36-063-79-167064	4296805	50	63	16	9	9	B																																							



SERVISVENTILER AV MÄSSING

Mässingsventiler med en genomtänkt konstruktion
Ventilerna har dricksvattengodkänt EPDM-gummi
Gjuten konstruktion som är frostsäker
Kan fås med klämringskoppling eller PRK-mutter
Ventilspindel av syrafast stål.

Dricksvattengodkända av KIWA

Uppgraderades under 2021 med spindel av DUPLEX 1.4362

NYHET

Serie 16/05-010

Servisventil med dragfasta
skruvkopplingar för PE-rör
Klarar även PVC-rör

Duplex spindel 1.4362

Mässing
PN 16
DN 25-50

AVK-toppanslutning



AVK nr.	RSK nr.	DN	PE-rör	PN	Vikt	St/pall	Kod
16-032-05-0040099	4303165	25	32	16	2,2	70	A
16-040-05-0040099	4303166	32	40	16	2,5	64	A
16-050-05-006	4303167	40	50	16	3	40	A
16-063-05-006	4303168	50	63	16	3,5	40	A

Serie 16/25-010

Servisventil med dragfasta
PRK-kopplingar för PE-rör

Duplex spindel 1.4362

Mässing
PN 16
DN 25-50

AVK-toppanslutning



AVK nr.	RSK nr.	DN	PE-rör	PN	Vikt	St/pall	Kod
16-025-25-0040099	4303140	20	25	16	1,5	70	B
16-032-25-0040099	4303141	25	32	16	2	64	A
16-040-25-0040099	4303142	32	40	16	2,3	60	A
16-050-25-006	4303143	40	50	16	3	40	A
16-063-25-006	4303144	50	63	16	3,5	32	A

Serie 16/00-010

Servisventil med dragfasta
skruvkopplingar för PE-rör
Klarar även PVC-rör

Duplex spindel 1.4362

Mässing
PN 16
DN 25-50

T-toppanslutning



AVK nr.	RSK nr.	DN	PE-rör	PN	Vikt	St/pall	Kod
16-032-00-0540099	4303169	25	32	16	2	70	B
16-040-00-0540099	4303170	32	40	16	2,4	64	B
16-050-00-056	4303171	40	50	16	3	42	B
16-063-00-056	4303172	50	63	16	3,5	36	B

Serie 16/20-010

Servisventil med dragfasta PRK-
skruvkopplingar för PE-rör

Duplex spindel 1.4362

T-toppanslutning
Mässing
PN 16
DN 25-50

T-toppanslutning



AVK nr.	RSK nr.	DN	PE-rör	PN	Vikt	St/pall	Kod
16-032-20-0540099	4303151	25	32	16	1,9	70	B
16-040-20-0540099	4303152	32	40	16	2,2	64	B
16-050-20-056	4303153	40	50	16	3	45	B
16-063-20-056	4303154	50	63	16	3,5	20	B

SERVISVENTILER AV POM



Kil av avzinkningsbeständig mässing som är vulkaniserad med dricksvattengodkänt EPDM-gummi
Ventilhuset är tillverkat av POM - Polyoxymetylen (acetalplast)
Ventilspindeln i rostfritt stål Spindeltätningen består av 2st O-ringar av EPDM-gummi och en avstrykarring av NBR-gummi

Dricksvattengodkända av KIWA

Serie 16/59-010

POM Servisventil med dragfasta snabbkopplingar för PE-rör
PN 16
DN 25-50
Snabbkopplingen är tillverkad av PP
32 och 40mm kan spännas med handkraft



AVK nr.	RSK nr.	DN	PE-rör	PN	Vikt	St/pall	Kod
16-032-59-004	4328468	25	32	16	1,4	50	A
16-040-59-004	4328469	32	40	16	1,8	32	A
16-050-59-004	4328470	40	50	16	2,81	28	A
16-063-59-004	4328471	50	63	16	3,71	20	A

Serie 16/69-001

POM Servisventil med Dragfasta snabbkopplingar för PE-rör
Duplex spindel 1.4362
PN 16
DN 25-50
Snabbkopplingen är tillverkad av PP
32 och 40mm kan spännas med handkraft



AVK nr.	RSK nr.	DN	PE-rör	PN	Vikt	St/pall	Kod
16-032-69-004	4328567	25	32	16	1,4	50	B
16-040-69-004	4328568	32	40	16	1,8	32	B
16-050-69-004	4328569	40	50	16	2,81	28	B
16-063-69-004	4328570	50	63	16	3,71	20	B

Serie 16/55-010

POM Servisventil med dragfasta insticksmuffar för PE-rör
Packas i plastpåse med 2 SDR 11 stödhylsor.
PN 16
DN 25-50
AVK-toppanslutning



AVK nr.	RSK nr.	DN	PE-rör	PN	Vikt	St/pall	Kod
16-032-55-006	4302005	25	32	16	1,38	50	A
16-040-55-006	4302012	32	40	16	1,58	40	A
16-050-55-006	4302013	40	50	16	4,4	28	A
16-063-55-006	4302019	50	63	16	4,9	20	A

Serie 16/80-026

POM servisventil för direkt sammansvetsning med PE-rör
PN 16
DN 25-50
AVK-toppanslutning



AVK nr.	RSK nr.	DN	PE-rör	PN	Vikt	St/pall	Kod
16-032-80-026	4302015	25	32	16	1,46	22	A
16-040-80-026	4302016	32	40	16	1,7	18	A
16-050-80-026	4302017	40	50	16	4,6	13	A
16-063-80-026	4302018	50	63	16	5	11	A

Serie 16/81-026

POM servisventil för direkt sammansvetsning med PE-rör
Duplex spindel 1.4362
PN 16
DN 25-50
AVK-toppanslutning



AVK nr.	RSK nr.	DN	PE-rör	PN	Vikt	St/pall	Kod
16-032-81-024	4328571	25	32	16	1,4	50	A
16-040-81-024	4328572	32	40	16	2,56	40	A
16-050-81-024	4328573	40	50	16	2,8	28	A
16-063-81-024	4328574	50	63	16	3,5	20	A

Serie 16/90-010

POM servisventil med dragfasta PRK-kopplingar för PE-rör
PN 16
DN 25-50

AVK-toppanslutning



AVK nr.	RSK nr.	DN	PE-rör	PN	Vikt	St/pall	Kod
16-032-90-006	4302001	25	32	16	1,4	50	A
16-040-90-006	4302002	32	40	16	2,56	40	A
16-050-90-006	4302003	40	50	16	2,8	28	A
16-063-90-006	4302004	50	63	16	3,5	20	A

NYHET

Serie 16/91-001

POM servisventil med dragfasta PRK-kopplingar

Duplex spindel 1.4362

för PE-rör
PN 16
DN 25-50

AVK-toppanslutning



AVK nr.	RSK nr.	DN	PE-rör	PN	Vikt	St/pall	Kod
16-032-91-004	4328575	25	32	16	1,4	50	B
16-040-91-004	4328576	32	40	16	2,56	40	B
16-050-91-004	4328577	40	50	16	2,8	28	B
16-063-91-004	4328578	50	63	16	3,5	20	B

Serie 16/57-010

POM Servisventil med dragfasta insticksmuffar för PE-rör

PN 16
DN 25-50

T-toppanslutning

Demonteringsverktyg för PE-rör finns på sidan 30



AVK nr.	RSK nr.	DN	PE-rör	PN	Vikt	St/pall	Kod
16-032-57-006	4302056	25	32	16	1,3	50	C
16-040-57-006	4302057	32	40	16	1,4	40	C
16-050-57-006	4302058	40	50	16	4,4	28	C
16-063-57-006	4302059	50	63	16	4,9	20	C

Serie 16/83-026

POM servisventil för direkt sammansvetsning med PE-rör

PN 16
DN 25-50

T-toppanslutning



AVK nr.	RSK nr.	DN	PE-rör	PN	Vikt	St/pall	Kod
16-032-83-026	4302052	25	32	16	1,4	22	C
16-040-83-026	4302053	32	40	16	1,6	18	C
16-050-83-026	4302054	40	50	16	4,6	13	C
16-063-83-026	4302055	50	63	16	5	11	C

Serie 16/93-010

POM servisventil med dragfasta PRK-kopplingar för PE-rör

PN 16
DN 25-50

T-toppanslutning



AVK nr.	RSK nr.	DN	PE-rör	PN	Vikt	St/pall	Kod
16-032-93-006	4302047	25	32	16	1,4	50	C
16-040-93-006	4302049	32	40	16	1,4	42	C
16-050-93-006	4302050	40	50	16	2,8	28	C
16-063-93-006	4302051	50	63	16	3,5	20	C



GARNITYR FÖR SERVISVENTILER

Nytt Lås-Clip
för snabbare
montering



NYHET

Serie 04

Teleskopiskt garnityr för
servisventiler
DN 25-50
Rostfri Betjäningsfyrkant i
Svensk standard
**Invändigt rör i
galvaniserat stål**
Rostfri Bottenadapter passande
AVK-toppanslutning



AVK nr.	RSK nr.	DN	Spindel- fyrkant mm	Längd mm	Vikt	St/pall	Kod
04-032-2-0003	4260420	25-50	12-15	450-700	1,7	72	A
04-032-2-0503	4260421	25-50	12-15	650-1100	2,4	72	A
04-032-2-0703	4260433	25-50	12-15	800-1400	2,5	48	A
04-032-2-1003	4260422	25-50	12-15	1050-1750	3,7	48	A
04-032-2-1203	4260432	25-50	12-15	1400-2350	3	55	A
04-032-2-1503	4260423	25-50	12-15	1700-2900	5,7	44	A
04-032-2-2003	4260437	25-50	12-15	2500-4700	9	55	A

Serie 04

Teleskopiskt garnityr för
servisventiler
DN 25-50
Rostfri Betjäningsfyrkant i
Svensk standard
**Invändigt rör i
rostfritt AISI 304**
Rostfri Bottenadapter passande
AVK-toppanslutning



AVK nr.	RSK nr.	DN	Spindel- fyrkant mm	Längd mm	Vikt	St/pall	Kod
04-032-2-000302	4260424	25-50	12-15	450-700	1,7	72	A
04-032-2-050302	4260425	25-50	12-15	650-1100	2,4	72	A
04-032-2-070302	4260434	25-50	12-15	800-1400	2,5	48	A
04-032-2-100302	4260426	25-50	12-15	1050-1750	3,7	48	A
04-032-2-120302	4260431	25-50	12-15	1400-2350	6	55	A
04-032-2-150302	4260427	25-50	12-15	1700-2900	5,4	44	A
04-032-2-200302	4260438	25-50	12-15	2500-4700	9	55	A

Serie 04

Teleskopiskt garnityr för
servisventiler
DN 25-50
Rostfri Betjäningsfyrkant i
Svensk standard
**Invändigt rör av
galvaniserat stål**
Rostfri Bottenadapter
passande **T-toppanslutning**



AVK nr.	RSK nr.	DN	Spindel- fyrkant mm	Längd mm	Vikt	St/pall	Kod
04-032-6-0003	4260338	25-50	12-15	450-700	1,7	72	C
04-032-6-0503	4260339	25-50	12-15	650-1100	2,4	72	C
04-032-6-0703	4260435	25-50	12-15	800-1400	2,5	48	C
04-032-6-1003	4260340	25-50	12-15	1050-1750	3,7	48	C
04-032-6-1203	4260341	25-50	12-15	1400-2350	4,7	55	C
04-032-6-1503	4260342	25-50	12-15	1700-2900	5,8	44	C
04-032-6-2003	4260343	25-50	12-15	2500-4700	7,2	55	C

Serie 04

Teleskopiskt garnityr för
servisventiler
DN 25-50
Rostfri Betjäningsfyrkant i
Svensk standard
**Invändigt rör i
rostfritt AISI 304**
Rostfri Bottenadapter
passande **T-toppanslutning**



AVK nr.	RSK nr.	DN	Spindel- fyrkant mm	Längd mm	Vikt	St/pall	Kod
04-032-6-000302	4260344	25-50	12-15	450-700	1,7	72	C
04-032-6-050302	4260345	25-50	12-15	650-1100	2,4	72	C
04-032-6-070302	4260443	25-50	12-15	800-1400	2,5	48	C
04-032-6-100302	4260346	25-50	12-15	1050-1750	3,6	48	C
04-032-6-120302	4260347	25-50	12-15	1400-2350	4,7	55	C
04-032-6-150302	4260348	25-50	12-15	1700-2900	5,8	44	C
04-032-6-200302	4260349	25-50	12-15	2500-4700	7,2	55	C



GARNITYR REPARATION OCH FÖRLÄNGNING

AVK Reparation och förlängningsgarnityr

Serie 04

Rep- Förlängnings garnityr för
servisventiler

DN 25-50

Betjäningsfyrkant Svensk
standard

Invändigt rör i rostfritt

AISI 304



AVK nr.	RSK nr.	DN	Spindel- fyrkant mm	Längd mm	Vikt	St/pall	Kod
04-032-A-450302	4219632	25-50	12-15	500	1	50	A
04-032-A-550302	4219633	25-50	12-15	1000	1,5	50	A
04-032-A-650302	4219634	25-50	12-15	1500	2	50	A

Serie 04

Rep- Förlängnings garnityr för
Slussventiler

DN 50-400

Betjäningsfyrkant Svensk
standard

Invändigt rör i rostfritt

AISI 304



AVK nr.	RSK nr.	DN	Spindel- fyrkant mm	Längd mm	Vikt	St/pall	Kod
04-990-B-450202	4219667	50-400	23-32	500	1,8	52	A
04-990-B-550202	4219668	50-400	23-32	1000	3	52	A
04-990-B-650202	4219669	50-400	23-32	1500	5,1	52	A



GARNITYR FÖR SERVISVENTILER

Med brytbar topp

Serie 04/07

Teleskopiskt garnityr för
servisventiler

DN 25-50
Brytbar topp

**Invändigt rör i
galvaniserat stål**

Bottenadapter passande

AVK-toppanslutning



AVK nr.	RSK nr.	DN	Spindel- fyrkant mm	Längd mm	Vikt	St/pall	Kod
04-032-2-0014	4219575	25-50	12-15	450-700	2,2	72	C
04-032-2-0514	4219576	25-50	12-15	650-1100	2,5	72	C
04-032-2-0714	4219577	25-50	12-15	800-1400	3	48	A
04-032-2-1014	4219578	25-50	12-15	1050-1750	3,6	48	A
04-032-2-1214	4219579	25-50	12-15	1400-2350	3,7	55	A
04-032-2-1514	4219580	25-50	12-15	1700-2900	4,4	44	C
04-032-2-2014	4219581	25-50	12-15	2500-4700	9	55	C

Serie 04/07

Teleskopiskt garnityr för
servisventiler

DN 25-50
Brytbar topp

**Invändigt rör i rostfritt AISI
304**

Bottenadapter passande

AVK-toppanslutning



AVK nr.	RSK nr.	DN	Spindel- fyrkant mm	Längd mm	Vikt	St/pall	Kod
04-032-2-001402	4219582	25-50	12-15	450-700	2,2	72	C
04-032-2-051402	4219583	25-50	12-15	650-1100	2,5	72	A
04-032-2-071402	4219584	25-50	12-15	800-1400	3	48	A
04-032-2-101402	4219585	25-50	12-15	1050-1750	3,5	48	A
04-032-2-121402	4219586	25-50	12-15	1400-2350	3,7	55	C
04-032-2-151402	4219587	25-50	12-15	1700-2900	4,4	44	C
04-032-2-201402	4219588	25-50	12-15	2500-4700	9	55	C



SLUSSVENTIL MED PE-RÖR

AVK Slussventiler med PE-ändar SDR 11 eller SDR 17
Det patenterade tätningssystemet är testat och godkänt av
DVGW och har visat sig överlägset jämfört med andra
system på marknaden Helt hermetiskt tillslutet

DN / PRODUKTER FÖR VATTEN

Serie 36/80-127

Slussventil med PE-rör
Spindeladapter ingår
Segjärn
EPDM gummibelagd kil



Epoxibeläggning
in- och utvändigt
PE 100-rör

PN 10, SDR 17
DN 65-500
Ø75 - 630 mm

AVK nr.	RSK nr.	DN	PE-rör	PN	Vikt	St/pall	Kod
36-075-80-2638	4255563	65	75	10	12	7	A
36-090-80-26386499	4255564	80	90	10	12	6	A
36-110-80-26386499	4255565	100	110	10	17	5	A
36-125-80-26386499	4255566	125	125	10	26	4	B
36-160-80-26386499	4255567	150	160	10	36	3	A
36-180-80-26386499	4255227	150	180	10	37	3	B
36-200-80-26386499	4255568	200	200	10	63	2	A
36-225-80-26386499	4255569	200	225	10	73	2	A
36-250-80-26386499	4255570	250	250	10	118	2	A
36-280-80-26386499	4255231	250	280	10	126	1	B
36-315-80-2638	4255571	300	315	10	140	1	A
36-355-80-2638	4255647	300	355	10	230	1	A
36-400-80-2638	4255648	400	400	10	376	1	A
36-450-80-2638	4296607	400	450	10	424	1	A
36-500-80-2638	4296608	400	500	10	486	1	A
36-560-80-2638	4296609	500	560	10	958	1	A
36-630-80-2638	4296610	500	630	10	1063	1	A

Serie 36/80-117

Slussventil med PE-rör
Spindeladapter ingår
Segjärn
EPDM gummibelagd kil



Epoxibeläggning
in- och utvändigt
PE 100-rör

PN 16, SDR 11
DN 65-500
Ø75 - 630 mm

AVK nr.	RSK nr.	DN	PE-rör	PN	Vikt	St/pall	Kod
36-075-80-1638	4255174	65	75	16	12	7	A
36-090-80-16386499	4255175	80	90	16	12	6	A
36-110-80-16386499	4255176	100	110	16	17	4	A
36-125-80-16386499	4255177	125	125	16	23	4	B
36-140-80-16386499	4255210	125	140	16	26	4	B
36-160-80-16386499	4255178	150	160	16	37	2	A
36-180-80-16386499	4255179	150	180	16	37	2	B
36-200-80-16386499	4255180	200	200	16	65	2	A
36-225-80-16386499	4255181	200	225	16	73	2	A
36-250-80-16386499	4255183	250	250	16	118	2	A
36-280-80-16386499	4255184	250	280	16	126	2	B
36-315-80-1638	4255268	300	315	16	140	1	A
36-355-80-1638	4255645	300	355	16	230	1	A
36-400-80-1638	4255646	400	400	16	376	1	A
36-450-80-1638	4296611	400	450	16	446	1	B
36-500-80-1638	4296612	400	500	16	513	1	B
36-560-80-1638	4296613	500	560	16	1013	1	B
36-630-80-1638	4296614	500	630	16	1134	1	B

Serie 36/80-137

Slussventil med
Safetec PE-rör
Spindeladapter ingår
Segjärn
EPDM gummibelagd kil



Epoxibeläggning
in- och utvändigt
PE 100-rör

PN 10, SDR 17
DN65-400

AVK nr.	RSK nr.	DN	PE-rör	PN	Vikt	St/pall	Kod
36-075-80-1838	4296438	65	75	10	12	7	C
36-090-80-18386499	4296439	80	90	10	12	6	B
36-110-80-18386499	4296440	100	110	10	17	4	B
36-125-80-18386499	4296441	125	125	10	26	4	B
36-160-80-18386499	4296442	150	160	10	36	2	B
36-180-80-18386499	4296443	150	180	10	36	2	B
36-200-80-18386499	4296444	200	200	10	63	2	B
36-225-80-18386499	4296445	200	225	10	72	2	B
36-250-80-1838	4296446	250	250	10	118	2	C
36-280-80-1838	4296447	250	280	10	126	2	C
36-315-80-1838	4296448	300	315	10	140	1	C
36-400-80-1838	4296450	400	400	10	376	1	C

Serie 36/80-147





Slussventil med
Safetec PE-rör
Spindeladapter ingår
Segjärn
EPDM gummibelagd kil



Epoxibeläggning
in- och utvändigt
PE 100-rör

PN 16, SDR 11
DN65-400

AVK nr.	RSK nr.	DN	PE-rör	PN	Vikt	St/pall	Kod
36-075-80-1938	4296451	65	75	16	12	7	C
36-090-80-19386499	4296452	80	90	16	12	6	B
36-110-80-19386499	4296453	100	110	16	17	4	B
36-125-80-19386499	4296454	125	125	16	26	4	B
36-160-80-19386499	4296455	150	160	16	36	2	B
36-200-80-19386499	4296457	200	200	16	63	2	B
36-225-80-19386499	4296458	200	225	16	72	2	B
36-250-80-1938	4296459	250	250	16	118	2	C
36-315-80-1938	4296461	300	315	16	140	1	C
36-400-80-1938	4296463	400	400	16	376	1	C

<p>Serie 36/79-127 Slussventil med PE-rör Spindeladapter ingår Duplex spindel 1.4362 Segjärn EPDM gummibelagd kil</p>  <p>Epoxibeläggning in- och utvändigt PE 100-rör PN 10, SDR 17 DN 65-500 Ø75 - 630 mm</p>	<p>NYHET</p> <table border="1"> <thead> <tr> <th>AVK nr.</th> <th>RSK nr.</th> <th>DN</th> <th>PE-rör</th> <th>PN</th> <th>Vikt</th> <th>St/pall</th> <th>Kod</th> </tr> </thead> <tbody> <tr><td>36-075-79-263864</td><td>4296824</td><td>65</td><td>75</td><td>10</td><td>12</td><td>7</td><td>B</td></tr> <tr><td>36-090-79-26386499</td><td>4296825</td><td>80</td><td>90</td><td>10</td><td>12</td><td>6</td><td>B</td></tr> <tr><td>36-110-79-26386499</td><td>4296826</td><td>100</td><td>110</td><td>10</td><td>17</td><td>5</td><td>B</td></tr> <tr><td>36-125-79-26386499</td><td>4296827</td><td>125</td><td>125</td><td>10</td><td>26</td><td>4</td><td>B</td></tr> <tr><td>36-160-79-26386499</td><td>4296828</td><td>150</td><td>160</td><td>10</td><td>36</td><td>3</td><td>B</td></tr> <tr><td>36-180-79-26386499</td><td>4296829</td><td>150</td><td>180</td><td>10</td><td>37</td><td>3</td><td>B</td></tr> <tr><td>36-200-79-26386499</td><td>4296830</td><td>200</td><td>200</td><td>10</td><td>63</td><td>2</td><td>B</td></tr> <tr><td>36-225-79-26386499</td><td>4296831</td><td>200</td><td>225</td><td>10</td><td>73</td><td>2</td><td>B</td></tr> <tr><td>36-250-79-263864</td><td>4296832</td><td>250</td><td>250</td><td>10</td><td>118</td><td>2</td><td>B</td></tr> <tr><td>36-280-79-263864</td><td>4296833</td><td>250</td><td>280</td><td>10</td><td>126</td><td>1</td><td>B</td></tr> <tr><td>36-315-79-263864</td><td>4296834</td><td>300</td><td>315</td><td>10</td><td>140</td><td>1</td><td>B</td></tr> <tr><td>36-355-79-263864</td><td>4296835</td><td>300</td><td>355</td><td>10</td><td>230</td><td>1</td><td>B</td></tr> <tr><td>36-400-79-263864</td><td>4296836</td><td>400</td><td>400</td><td>10</td><td>376</td><td>1</td><td>B</td></tr> <tr><td>36-450-79-263864</td><td>4296837</td><td>400</td><td>450</td><td>10</td><td>424</td><td>1</td><td>B</td></tr> <tr><td>36-500-79-263864</td><td>4296838</td><td>400</td><td>500</td><td>10</td><td>486</td><td>1</td><td>B</td></tr> <tr><td>36-560-79-263064</td><td>4296839</td><td>500</td><td>560</td><td>10</td><td>958</td><td>1</td><td>B</td></tr> <tr><td>36-630-79-263064</td><td>4296840</td><td>500</td><td>630</td><td>10</td><td>1063</td><td>1</td><td>B</td></tr> </tbody> </table>	AVK nr.	RSK nr.	DN	PE-rör	PN	Vikt	St/pall	Kod	36-075-79-263864	4296824	65	75	10	12	7	B	36-090-79-26386499	4296825	80	90	10	12	6	B	36-110-79-26386499	4296826	100	110	10	17	5	B	36-125-79-26386499	4296827	125	125	10	26	4	B	36-160-79-26386499	4296828	150	160	10	36	3	B	36-180-79-26386499	4296829	150	180	10	37	3	B	36-200-79-26386499	4296830	200	200	10	63	2	B	36-225-79-26386499	4296831	200	225	10	73	2	B	36-250-79-263864	4296832	250	250	10	118	2	B	36-280-79-263864	4296833	250	280	10	126	1	B	36-315-79-263864	4296834	300	315	10	140	1	B	36-355-79-263864	4296835	300	355	10	230	1	B	36-400-79-263864	4296836	400	400	10	376	1	B	36-450-79-263864	4296837	400	450	10	424	1	B	36-500-79-263864	4296838	400	500	10	486	1	B	36-560-79-263064	4296839	500	560	10	958	1	B	36-630-79-263064	4296840	500	630	10	1063	1	B								
AVK nr.	RSK nr.	DN	PE-rör	PN	Vikt	St/pall	Kod																																																																																																																																																		
36-075-79-263864	4296824	65	75	10	12	7	B																																																																																																																																																		
36-090-79-26386499	4296825	80	90	10	12	6	B																																																																																																																																																		
36-110-79-26386499	4296826	100	110	10	17	5	B																																																																																																																																																		
36-125-79-26386499	4296827	125	125	10	26	4	B																																																																																																																																																		
36-160-79-26386499	4296828	150	160	10	36	3	B																																																																																																																																																		
36-180-79-26386499	4296829	150	180	10	37	3	B																																																																																																																																																		
36-200-79-26386499	4296830	200	200	10	63	2	B																																																																																																																																																		
36-225-79-26386499	4296831	200	225	10	73	2	B																																																																																																																																																		
36-250-79-263864	4296832	250	250	10	118	2	B																																																																																																																																																		
36-280-79-263864	4296833	250	280	10	126	1	B																																																																																																																																																		
36-315-79-263864	4296834	300	315	10	140	1	B																																																																																																																																																		
36-355-79-263864	4296835	300	355	10	230	1	B																																																																																																																																																		
36-400-79-263864	4296836	400	400	10	376	1	B																																																																																																																																																		
36-450-79-263864	4296837	400	450	10	424	1	B																																																																																																																																																		
36-500-79-263864	4296838	400	500	10	486	1	B																																																																																																																																																		
36-560-79-263064	4296839	500	560	10	958	1	B																																																																																																																																																		
36-630-79-263064	4296840	500	630	10	1063	1	B																																																																																																																																																		
<p>Serie 36/79-117 Slussventil med PE-rör Spindeladapter ingår Duplex spindel 1.4362 Segjärn EPDM gummibelagd kil</p>  <p>Epoxibeläggning in- och utvändigt PE 100-rör PN 10, SDR 11 DN 65-500 Ø75 - 630 mm</p>	<p>NYHET</p> <table border="1"> <thead> <tr> <th>AVK nr.</th> <th>RSK nr.</th> <th>DN</th> <th>PE-rör</th> <th>PN</th> <th>Vikt</th> <th>St/pall</th> <th>Kod</th> </tr> </thead> <tbody> <tr><td>36-075-79-163864</td><td>4296806</td><td>65</td><td>75</td><td>16</td><td>12</td><td>7</td><td>B</td></tr> <tr><td>36-090-79-16386499</td><td>4296807</td><td>80</td><td>90</td><td>16</td><td>12</td><td>6</td><td>B</td></tr> <tr><td>36-110-79-16386499</td><td>4296808</td><td>100</td><td>110</td><td>16</td><td>17</td><td>4</td><td>B</td></tr> <tr><td>36-125-79-16386499</td><td>4296809</td><td>125</td><td>125</td><td>16</td><td>23</td><td>4</td><td>B</td></tr> <tr><td>36-140-79-16386499</td><td>4296810</td><td>125</td><td>140</td><td>16</td><td>26</td><td>4</td><td>B</td></tr> <tr><td>36-160-79-16386499</td><td>4296811</td><td>150</td><td>160</td><td>16</td><td>37</td><td>2</td><td>B</td></tr> <tr><td>36-180-79-16386499</td><td>4296812</td><td>150</td><td>180</td><td>16</td><td>37</td><td>2</td><td>B</td></tr> <tr><td>36-200-79-16386499</td><td>4296813</td><td>200</td><td>200</td><td>16</td><td>65</td><td>2</td><td>B</td></tr> <tr><td>36-225-79-16386499</td><td>4296814</td><td>200</td><td>225</td><td>16</td><td>73</td><td>2</td><td>B</td></tr> <tr><td>36-250-79-163864</td><td>4296815</td><td>250</td><td>250</td><td>16</td><td>118</td><td>2</td><td>B</td></tr> <tr><td>36-280-79-163864</td><td>4296816</td><td>250</td><td>280</td><td>16</td><td>126</td><td>2</td><td>B</td></tr> <tr><td>36-315-79-163864</td><td>4296817</td><td>300</td><td>315</td><td>16</td><td>140</td><td>1</td><td>B</td></tr> <tr><td>36-355-79-163864</td><td>4296818</td><td>300</td><td>355</td><td>16</td><td>230</td><td>1</td><td>B</td></tr> <tr><td>36-400-79-163864</td><td>4296819</td><td>400</td><td>400</td><td>16</td><td>376</td><td>1</td><td>B</td></tr> <tr><td>36-450-79-163864</td><td>4296820</td><td>400</td><td>450</td><td>16</td><td>446</td><td>1</td><td>B</td></tr> <tr><td>36-500-79-163864</td><td>4296821</td><td>400</td><td>500</td><td>16</td><td>513</td><td>1</td><td>B</td></tr> <tr><td>36-560-79-163064</td><td>4296822</td><td>500</td><td>560</td><td>16</td><td>1013</td><td>1</td><td>B</td></tr> <tr><td>36-630-79-163064</td><td>4296823</td><td>500</td><td>630</td><td>16</td><td>1134</td><td>1</td><td>B</td></tr> </tbody> </table>	AVK nr.	RSK nr.	DN	PE-rör	PN	Vikt	St/pall	Kod	36-075-79-163864	4296806	65	75	16	12	7	B	36-090-79-16386499	4296807	80	90	16	12	6	B	36-110-79-16386499	4296808	100	110	16	17	4	B	36-125-79-16386499	4296809	125	125	16	23	4	B	36-140-79-16386499	4296810	125	140	16	26	4	B	36-160-79-16386499	4296811	150	160	16	37	2	B	36-180-79-16386499	4296812	150	180	16	37	2	B	36-200-79-16386499	4296813	200	200	16	65	2	B	36-225-79-16386499	4296814	200	225	16	73	2	B	36-250-79-163864	4296815	250	250	16	118	2	B	36-280-79-163864	4296816	250	280	16	126	2	B	36-315-79-163864	4296817	300	315	16	140	1	B	36-355-79-163864	4296818	300	355	16	230	1	B	36-400-79-163864	4296819	400	400	16	376	1	B	36-450-79-163864	4296820	400	450	16	446	1	B	36-500-79-163864	4296821	400	500	16	513	1	B	36-560-79-163064	4296822	500	560	16	1013	1	B	36-630-79-163064	4296823	500	630	16	1134	1	B
AVK nr.	RSK nr.	DN	PE-rör	PN	Vikt	St/pall	Kod																																																																																																																																																		
36-075-79-163864	4296806	65	75	16	12	7	B																																																																																																																																																		
36-090-79-16386499	4296807	80	90	16	12	6	B																																																																																																																																																		
36-110-79-16386499	4296808	100	110	16	17	4	B																																																																																																																																																		
36-125-79-16386499	4296809	125	125	16	23	4	B																																																																																																																																																		
36-140-79-16386499	4296810	125	140	16	26	4	B																																																																																																																																																		
36-160-79-16386499	4296811	150	160	16	37	2	B																																																																																																																																																		
36-180-79-16386499	4296812	150	180	16	37	2	B																																																																																																																																																		
36-200-79-16386499	4296813	200	200	16	65	2	B																																																																																																																																																		
36-225-79-16386499	4296814	200	225	16	73	2	B																																																																																																																																																		
36-250-79-163864	4296815	250	250	16	118	2	B																																																																																																																																																		
36-280-79-163864	4296816	250	280	16	126	2	B																																																																																																																																																		
36-315-79-163864	4296817	300	315	16	140	1	B																																																																																																																																																		
36-355-79-163864	4296818	300	355	16	230	1	B																																																																																																																																																		
36-400-79-163864	4296819	400	400	16	376	1	B																																																																																																																																																		
36-450-79-163864	4296820	400	450	16	446	1	B																																																																																																																																																		
36-500-79-163864	4296821	400	500	16	513	1	B																																																																																																																																																		
36-560-79-163064	4296822	500	560	16	1013	1	B																																																																																																																																																		
36-630-79-163064	4296823	500	630	16	1134	1	B																																																																																																																																																		
<p>Serie 36/80-267 Slussventil med PE-rör Spindeladapter ingår Segjärn EPDM gummibelagd kil</p>  <p>Epoxibeläggning utvändigt, invändig emaljering PE-rör i PE 100 PN 10, SDR 17 DN 65-300</p>	<table border="1"> <thead> <tr> <th>AVK nr.</th> <th>RSK nr.</th> <th>DN</th> <th>PE-rör</th> <th>PN</th> <th>Vikt</th> <th>St/pall</th> <th>Kod</th> </tr> </thead> <tbody> <tr><td>36-075-80-267</td><td>4255900</td><td>65</td><td>75</td><td>10</td><td>12</td><td>7</td><td>B</td></tr> <tr><td>36-090-80-26706499</td><td>4255901</td><td>80</td><td>90</td><td>10</td><td>20</td><td>6</td><td>B</td></tr> <tr><td>36-110-80-26706499</td><td>4255902</td><td>100</td><td>110</td><td>10</td><td>17</td><td>5</td><td>B</td></tr> <tr><td>36-125-80-26706499</td><td>4255903</td><td>125</td><td>125</td><td>10</td><td>23</td><td>4</td><td>B</td></tr> <tr><td>36-160-80-26706499</td><td>4255904</td><td>150</td><td>160</td><td>10</td><td>37</td><td>3</td><td>B</td></tr> <tr><td>36-180-80-26706499</td><td>4255937</td><td>150</td><td>180</td><td>10</td><td>37</td><td>3</td><td>B</td></tr> <tr><td>36-200-80-26706499</td><td>4255905</td><td>200</td><td>200</td><td>10</td><td>65</td><td>2</td><td>B</td></tr> <tr><td>36-225-80-26706499</td><td>4255906</td><td>200</td><td>225</td><td>10</td><td>73</td><td>2</td><td>C</td></tr> <tr><td>36-250-80-267</td><td>4255907</td><td>250</td><td>250</td><td>10</td><td>118</td><td>3</td><td>C</td></tr> <tr><td>36-280-80-267</td><td>4255218</td><td>250</td><td>280</td><td>10</td><td>126</td><td>2</td><td>C</td></tr> <tr><td>36-315-80-267</td><td>4255908</td><td>300</td><td>315</td><td>10</td><td>189</td><td>1</td><td>C</td></tr> </tbody> </table>	AVK nr.	RSK nr.	DN	PE-rör	PN	Vikt	St/pall	Kod	36-075-80-267	4255900	65	75	10	12	7	B	36-090-80-26706499	4255901	80	90	10	20	6	B	36-110-80-26706499	4255902	100	110	10	17	5	B	36-125-80-26706499	4255903	125	125	10	23	4	B	36-160-80-26706499	4255904	150	160	10	37	3	B	36-180-80-26706499	4255937	150	180	10	37	3	B	36-200-80-26706499	4255905	200	200	10	65	2	B	36-225-80-26706499	4255906	200	225	10	73	2	C	36-250-80-267	4255907	250	250	10	118	3	C	36-280-80-267	4255218	250	280	10	126	2	C	36-315-80-267	4255908	300	315	10	189	1	C																																																								
AVK nr.	RSK nr.	DN	PE-rör	PN	Vikt	St/pall	Kod																																																																																																																																																		
36-075-80-267	4255900	65	75	10	12	7	B																																																																																																																																																		
36-090-80-26706499	4255901	80	90	10	20	6	B																																																																																																																																																		
36-110-80-26706499	4255902	100	110	10	17	5	B																																																																																																																																																		
36-125-80-26706499	4255903	125	125	10	23	4	B																																																																																																																																																		
36-160-80-26706499	4255904	150	160	10	37	3	B																																																																																																																																																		
36-180-80-26706499	4255937	150	180	10	37	3	B																																																																																																																																																		
36-200-80-26706499	4255905	200	200	10	65	2	B																																																																																																																																																		
36-225-80-26706499	4255906	200	225	10	73	2	C																																																																																																																																																		
36-250-80-267	4255907	250	250	10	118	3	C																																																																																																																																																		
36-280-80-267	4255218	250	280	10	126	2	C																																																																																																																																																		
36-315-80-267	4255908	300	315	10	189	1	C																																																																																																																																																		
<p>Serie 36/79-187 Slussventil med PE-rör Spindeladapter ingår Duplex spindel 1.4362 Segjärn EPDM gummibelagd kil</p>  <p>Epoxibeläggning utvändigt, invändig emaljering PE-rör i PE 100 PN 16, SDR 11 DN 65-300</p>	<p>NYHET</p> <table border="1"> <thead> <tr> <th>AVK nr.</th> <th>RSK nr.</th> <th>DN</th> <th>PE-rör</th> <th>PN</th> <th>Vikt</th> <th>St/pall</th> <th>Kod</th> </tr> </thead> <tbody> <tr><td>36-075-79-167864</td><td>4296867</td><td>65</td><td>75</td><td>16</td><td>12</td><td>7</td><td>B</td></tr> <tr><td>36-090-79-16786499</td><td>4296868</td><td>80</td><td>90</td><td>16</td><td>20</td><td>6</td><td>B</td></tr> <tr><td>36-110-79-16786499</td><td>4296869</td><td>100</td><td>110</td><td>16</td><td>17</td><td>5</td><td>B</td></tr> <tr><td>36-125-79-16786499</td><td>4296870</td><td>125</td><td>125</td><td>16</td><td>23</td><td>4</td><td>B</td></tr> <tr><td>36-140-79-16786499</td><td>4296871</td><td>125</td><td>140</td><td>16</td><td>37</td><td>3</td><td>B</td></tr> <tr><td>36-160-79-16786499</td><td>4296872</td><td>150</td><td>160</td><td>16</td><td>37</td><td>3</td><td>B</td></tr> <tr><td>36-180-79-16786499</td><td>4296873</td><td>150</td><td>180</td><td>16</td><td>37</td><td>3</td><td>B</td></tr> <tr><td>36-200-79-16786499</td><td>4296874</td><td>200</td><td>200</td><td>16</td><td>65</td><td>2</td><td>B</td></tr> <tr><td>36-225-79-16786499</td><td>4296875</td><td>200</td><td>225</td><td>16</td><td>73</td><td>2</td><td>B</td></tr> <tr><td>36-250-79-167864</td><td>4296876</td><td>250</td><td>250</td><td>16</td><td>118</td><td>3</td><td>B</td></tr> <tr><td>36-280-79-167864</td><td>4296877</td><td>250</td><td>280</td><td>16</td><td>126</td><td>2</td><td>C</td></tr> <tr><td>36-315-79-167864</td><td>4296878</td><td>300</td><td>315</td><td>16</td><td>189</td><td>1</td><td>B</td></tr> </tbody> </table>	AVK nr.	RSK nr.	DN	PE-rör	PN	Vikt	St/pall	Kod	36-075-79-167864	4296867	65	75	16	12	7	B	36-090-79-16786499	4296868	80	90	16	20	6	B	36-110-79-16786499	4296869	100	110	16	17	5	B	36-125-79-16786499	4296870	125	125	16	23	4	B	36-140-79-16786499	4296871	125	140	16	37	3	B	36-160-79-16786499	4296872	150	160	16	37	3	B	36-180-79-16786499	4296873	150	180	16	37	3	B	36-200-79-16786499	4296874	200	200	16	65	2	B	36-225-79-16786499	4296875	200	225	16	73	2	B	36-250-79-167864	4296876	250	250	16	118	3	B	36-280-79-167864	4296877	250	280	16	126	2	C	36-315-79-167864	4296878	300	315	16	189	1	B																																																
AVK nr.	RSK nr.	DN	PE-rör	PN	Vikt	St/pall	Kod																																																																																																																																																		
36-075-79-167864	4296867	65	75	16	12	7	B																																																																																																																																																		
36-090-79-16786499	4296868	80	90	16	20	6	B																																																																																																																																																		
36-110-79-16786499	4296869	100	110	16	17	5	B																																																																																																																																																		
36-125-79-16786499	4296870	125	125	16	23	4	B																																																																																																																																																		
36-140-79-16786499	4296871	125	140	16	37	3	B																																																																																																																																																		
36-160-79-16786499	4296872	150	160	16	37	3	B																																																																																																																																																		
36-180-79-16786499	4296873	150	180	16	37	3	B																																																																																																																																																		
36-200-79-16786499	4296874	200	200	16	65	2	B																																																																																																																																																		
36-225-79-16786499	4296875	200	225	16	73	2	B																																																																																																																																																		
36-250-79-167864	4296876	250	250	16	118	3	B																																																																																																																																																		
36-280-79-167864	4296877	250	280	16	126	2	C																																																																																																																																																		
36-315-79-167864	4296878	300	315	16	189	1	B																																																																																																																																																		
<p>Serie 36/80-167 Slussventil med PE-rör Spindeladapter ingår Segjärn EPDM gummibelagd kil</p>  <p>Epoxibeläggning utvändigt, invändig emaljering PE-rör i PE 100 PN 16, SDR 11 DN 65-300</p>	<table border="1"> <thead> <tr> <th>AVK nr.</th> <th>RSK nr.</th> <th>DN</th> <th>PE-rör</th> <th>PN</th> <th>Vikt</th> <th>St/pall</th> <th>Kod</th> </tr> </thead> <tbody> <tr><td>36-075-80-167</td><td>4255909</td><td>65</td><td>75</td><td>16</td><td>12</td><td>7</td><td>C</td></tr> <tr><td>36-090-80-16706499</td><td>4255910</td><td>80</td><td>90</td><td>16</td><td>20</td><td>6</td><td>B</td></tr> <tr><td>36-110-80-16706499</td><td>4255911</td><td>100</td><td>110</td><td>16</td><td>17</td><td>5</td><td>A</td></tr> <tr><td>36-125-80-16706499</td><td>4255912</td><td>125</td><td>125</td><td>16</td><td>23</td><td>4</td><td>B</td></tr> <tr><td>36-140-80-167</td><td>4255211</td><td>125</td><td>140</td><td>16</td><td>26</td><td>4</td><td>C</td></tr> <tr><td>36-160-80-16706499</td><td>4255913</td><td>150</td><td>160</td><td>16</td><td>37</td><td>3</td><td>A</td></tr> <tr><td>36-180-80-16706499</td><td>4255936</td><td>150</td><td>180</td><td>16</td><td>37</td><td>3</td><td>C</td></tr> <tr><td>36-200-80-16706499</td><td>4255914</td><td>200</td><td>200</td><td>16</td><td>65</td><td>2</td><td>A</td></tr> <tr><td>36-225-80-16706499</td><td>4255915</td><td>200</td><td>225</td><td>16</td><td>73</td><td>2</td><td>B</td></tr> <tr><td>36-250-80-167</td><td>4255916</td><td>250</td><td>250</td><td>16</td><td>118</td><td>3</td><td>C</td></tr> <tr><td>36-280-80-167</td><td>4255217</td><td>250</td><td>280</td><td>16</td><td>126</td><td>1</td><td>C</td></tr> <tr><td>36-315-80-167</td><td>4255917</td><td>300</td><td>315</td><td>16</td><td>189</td><td>1</td><td>C</td></tr> </tbody> </table>	AVK nr.	RSK nr.	DN	PE-rör	PN	Vikt	St/pall	Kod	36-075-80-167	4255909	65	75	16	12	7	C	36-090-80-16706499	4255910	80	90	16	20	6	B	36-110-80-16706499	4255911	100	110	16	17	5	A	36-125-80-16706499	4255912	125	125	16	23	4	B	36-140-80-167	4255211	125	140	16	26	4	C	36-160-80-16706499	4255913	150	160	16	37	3	A	36-180-80-16706499	4255936	150	180	16	37	3	C	36-200-80-16706499	4255914	200	200	16	65	2	A	36-225-80-16706499	4255915	200	225	16	73	2	B	36-250-80-167	4255916	250	250	16	118	3	C	36-280-80-167	4255217	250	280	16	126	1	C	36-315-80-167	4255917	300	315	16	189	1	C																																																
AVK nr.	RSK nr.	DN	PE-rör	PN	Vikt	St/pall	Kod																																																																																																																																																		
36-075-80-167	4255909	65	75	16	12	7	C																																																																																																																																																		
36-090-80-16706499	4255910	80	90	16	20	6	B																																																																																																																																																		
36-110-80-16706499	4255911	100	110	16	17	5	A																																																																																																																																																		
36-125-80-16706499	4255912	125	125	16	23	4	B																																																																																																																																																		
36-140-80-167	4255211	125	140	16	26	4	C																																																																																																																																																		
36-160-80-16706499	4255913	150	160	16	37	3	A																																																																																																																																																		
36-180-80-16706499	4255936	150	180	16	37	3	C																																																																																																																																																		
36-200-80-16706499	4255914	200	200	16	65	2	A																																																																																																																																																		
36-225-80-16706499	4255915	200	225	16	73	2	B																																																																																																																																																		
36-250-80-167	4255916	250	250	16	118	3	C																																																																																																																																																		
36-280-80-167	4255217	250	280	16	126	1	C																																																																																																																																																		
36-315-80-167	4255917	300	315	16	189	1	C																																																																																																																																																		

PREMIUM 100 VENTILEN

NYHET

En ventil som är tillverkad av den högsta kvaliteten på marknaden. Ger lång livslängd och maximum trygghet.

Ger en trygg och säker tillförlitlighet på vatten och avloppsnätet. Ventilen säkrar våra resurser av vatten och följer FN's hållbara mål. Ventilen är idealisk att placera där det är svårt att byta ventiler. Ska monteras på platser där lång livslängd och säkerhet är extra viktigt. AVKs välkända slussventiler med högsta kvalitet Finns nu upp till DN 1000. Lågt öppnings och stängningsmoment på alla storlekar.

Planerad lansering under våren 2022





FLÄNSADE SLUSSVENTILER DIN F4/F5 DN 40-1000

AVKs välkända slussventiler med högsta kvalitet
Finns nu upp till DN 1000
Lågt öppnings- och stängningsmoment på alla storlekar

Serie 06/30-0038

Flänsad slussventil
Spindeladapter ingår
Kort bygglängd DIN F4
Segjärn
EPDM gummibelagd kil
W-270 godkänt EPDM-gummi
Epoxibeläggning
in- och utvändigt
PN 16 bar
DN 40-1000
Finns även i PN16



AVK nr.	RSK nr.	DN	PN	Vikt	St/pall	Kod
06-040-30-8146499	4255309	40	10/16	7,5	25	A
06-050-30-8146499	4255300	50	10/16	8,8	30	A
06-065-30-8146499	4255301	65	10/16	11	25	A
06-080-30-8146499	4255302	80	10/16	14	20	A
06-100-30-8146499	4255303	100	10/16	17	15	A
06-125-30-8146499	4296464	125	10/16	22	15	A
06-150-30-8146499	4255305	150	10/16	31	10	A
06-200-30-8046499	4296465	200	10	48	10	A
06-250-30-8046499	4255307	250	10	102	8	A
06-300-30-8046487	4255308	300	10	110	6	A
06-350-30-804	4255383	350	10	220	2	A
06-400-30-804	4255384	400	10	240	2	A
06-450-30-006	4255395	450	10	487	1	A
06-500-30-006	4255396	500	10	559	1	A
06-600-30-006	4255397	600	10	762	1	A
06-700-30-00464	4296615	700	10	1 403	1	B
06-800-30-00464	4296605	800	10	1 475	1	B
06-900-30-00464	4296617	900	10	3 098	1	B
06-1000-30-09043164	4296619	1000	10	3 141	1	B

AVK nr.	RSK nr.	DN	PN	Vikt	St/pall	Kod
06-200-30-8146499	4255398	200	16	48	10	A
06-250-30-8146499	4255399	250	16	102	8	A
06-300-30-8146487	4255400	300	16	110	6	A
06-350-30-814	4255401	350	16	220	2	A
06-400-30-814	4255403	400	16	240	2	A
06-450-30-016	4255404	450	16	487	1	A
06-500-30-016	4255405	500	16	559	1	A
06-600-30-016	4255406	600	16	762	1	A
06-700-30-01464	4296621	700	16	1 447	1	B
06-800-30-01464	4296623	800	16	1 543	1	B
06-900-30-01464	4296625	900	16	3 131	1	B
06-1000-30-09143164	4296627	1000	16	3 203	1	B

Serie 06/35-003

Flänsad slussventil
kort bygglängd DIN F4
med lägesindikator
Segjärn
EPDM gummibelagd kil
Epoxibeläggning
in- och utvändigt
PN 10/16
DN 50-300



AVK nr.	RSK nr.	DN	PN	Vikt	St/pall	Kod
06-050-35-016	4417177	50	10/16	12,5	28	A
06-065-35-016	4417205	65	10/16	16	20	B
06-080-35-016	4417178	80	10/16	20	18	A
06-100-35-016	4417179	100	10/16	26,5	16	A
06-125-35-016	4417029	125	10/16	35,5	10	B
06-150-35-016	4417030	150	10	50,5	5	A
06-200-35-006	4417031	200	10	71	3	A
06-250-35-006	4417032	250	10	102	2	B
06-300-35-006	4417033	300	10	110	2	B

Serie 06/39-012

Flänsad slussventil
Spindeladapter ingår
Kort bygglängd DIN F4
Duplex spindel 1.4362
Segjärn
EPDM gummibelagd kil
W-270 godkänt EPDM-gummi
Epoxibeläggning
in- och utvändigt
PN 16 bar
DN 40-600
Finns även i PN16

NYHET

AVK nr.	RSK nr.	DN	PN	Vikt	St/pall	Kod
06-040-39-8146499	4296769	40	10/16	7,5	25	A
06-050-39-8146499	4296770	50	10/16	8,8	30	A
06-065-39-8146499	4296771	65	10/16	11	25	A
06-080-39-8146499	4296772	80	10/16	14	20	A
06-100-39-8146499	4296773	100	10/16	17	15	A
06-125-39-8146499	4296774	125	10/16	22	15	A
06-150-39-8146499	4296775	150	10/16	31	10	A
06-200-39-8046499	4296776	200	10	48	10	A
06-250-39-8046499	4296777	250	10	102	8	A
06-300-39-8046487	4296778	300	10	110	6	A
06-350-39-80464	4296779	350	10	220	2	A
06-400-39-80464	4296780	400	10	240	2	A
06-450-39-006	4296781	450	10	487	1	A
06-500-39-006	4296782	500	10	559	1	A
06-600-39-006	4296783	600	10	762	1	A

AVK nr.	RSK nr.	DN	PN	Vikt	St/pall	Kod
06-200-39-8146499	4296787	200	16	48	10	A
06-250-39-8146499	4296788	250	16	102	8	A
06-300-39-8146487	4296789	300	16	110	6	A
06-350-39-81464	4296790	350	16	220	2	A
06-400-39-81464	4296791	400	16	240	2	A
06-450-39-016	4296792	450	16	487	1	A
06-500-39-016	4296793	500	16	762	1	A
06-600-39-016	4296794	600	16	1 458	1	B

Serie 06/42-001

Flänsad slussventil
kort bygglängd DIN F4
Hus av DUPLEX 1.4362
NBR gummibelagd kil
PN 10/16
DN 50-300

NYHET

AVK nr.	RSK nr.	DN	PN	Vikt	St/pall	Kod
06-040-42-01395	4296936	40	10/16	8,4	30	C
06-050-42-01395	4296937	50	10/16	9,7	30	C
06-065-42-01395	4296938	65	10/16	11,5	20	C
06-080-42-01395	4296939	80	10/16	14,2	20	C
06-100-42-01395	4296940	100	10/16	16,5	15	C
06-125-42-01395	4296941	125	10/16	28	15	C
06-150-42-01395	4296942	150	10/16	31	10	C
06-200-42-00395	4296943	200	10	48	10	C
06-200-42-01395	4296944	200	16	48	10	C

Serie 02/60-003

Flänsad slussventil
Spindeladapter ingår
Lång bygglängd DIN F5
Segjärn
EPDM gummibelagd kil
Epoxibeläggning
in- och utvändigt
PN 10
DN 50-500



Obs:
* 400 mm genomlopp
** reducerat 400 mm genomlopp

AVK nr.	RSK nr.	DN	PN	Vikt	St/pall	Kod
02-050-60-014649	4296466	50	10	9,7	20	A
02-065-60-014649	4296467	65	10	12	17	A
02-080-60-014649	4296468	80	10	16	14	A
02-100-60-014649	4296469	100	10	18	12	A
02-125-60-014649	4296470	125	10	24	9	C
02-150-60-014649	4296471	150	10	34	8	A
02-200-60-004649	4296472	200	10	54	6	A
02-250-60-004649	4296473	250	10	110	4	A
02-300-60-004647	4296474	300	10	160	2	A
02-350-60-006 *	4296475	350	10	320	2	B
02-400-60-006	4296476	400	10	342	2	A
02-450-60-006 **	4296477	450	10	360	1	B
02-500-60-006 **	4296478	500	10	417	1	B

Serie 02/94-001

Flänsad slussventil
Spindeladapter ingår
Lång bygglängd DIN F5
Duplex spindel 1.4362
Segjärn
EPDM gummibelagd kil
Epoxibeläggning
PN 10
DN 50-500
Obs:
* 400 mm genomlopp
** reducerat 400 mm genomlopp

NYHET

AVK nr.	RSK nr.	DN	PN	Vikt	St/pall	Kod
02-050-94-01410902	4296749	50	10	9,7	20	A
02-065-94-01410902	4296750	65	10	12	17	A
02-080-94-01410902	4296751	80	10	16	14	A
02-100-94-01410902	4296752	100	10	18	12	A
02-125-94-01410902	4296753	125	10	24	9	C
02-150-94-01410902	4296754	150	10	34	8	A
02-200-94-00410902	4296755	200	10	54	6	A
02-250-94-00410902	4296757	250	10	110	4	A
02-300-94-00410702	4296759	300	10	160	2	A
02-350-94-00410002	4296761	350	10	320	2	B
02-400-94-00410002	4296763	400	10	342	2	A
02-450-94-00410002	4296765	450	10	360	1	B
02-500-94-00410002	4296767	500	10	417	1	B

Serie 26/00-009
 Flänsad slussventil
 kort bygglängd
 Spindeladapter ingår
 DIN F4
 Segjärn
 EPDM gummibelagd kil
Emaljbelagd invändigt
 Epoxibeläggning utvändigt
 PN 10/16
 DN 50-300



AVK nr.	RSK nr.	DN	PN	Vikt	St/pall	Kod
26-050-00-0147099	4255494	50	10/16	9	30	A
26-080-00-0147099	4255495	80	10/16	14	20	A
26-100-00-0147099	4255496	100	10/16	17	20	A
26-125-00-0147099	4255497	125	10/16	22	15	A
26-150-00-0147099	4255498	150	10/16	31	14	B
26-200-00-0047099	4255499	200	10	48	10	B
26-250-00-007	4255501	250	10	102	8	B
26-300-00-007	4255503	300	10	110	6	B

AVK nr.	RSK nr.	DN	PN	Vikt	St/pall	Kod
26-200-00-0147099	4255500	200	16	48	10	B
26-250-00-017	4255502	250	16	102	8	B
26-300-00-017	4255504	300	16	110	6	B

Serie 15/42-003
 Flänsad slussventil
förberedd för manöverdon
Kort bygglängd DIN F4
 Segjärn
 EPDM gummibelagd kil
 Epoxibeläggning
 in- och utvändigt
 PN 10/16
 DN 40-300

Alternativ:
 - Elektriskt manöverdon



AVK nr.	RSK nr.	DN	PN	Vikt	St/pall	Kod
15-050-40-016	4417161	50	10/16	14	30	B
15-065-42-016	4417162	65	10/16	17	25	B
15-080-42-01464099	4417163	80	10/16	21	20	B
15-100-42-01464099	4417164	100	10/16	26	20	B
15-125-42-01464099	4417165	125	10/16	34	15	C
15-150-42-01464099	4417166	150	10/16	49	10	B
15-200-42-00464099	4417167	200	10	68	10	B
15-250-42-006	4417169	250	10	113	8	B
15-300-42-006	4417170	300	10	160	6	B
15-350-40-006	4296924	350	10	223	4	C
15-400-40-006	4417147	400	10	243	2	B

Serie 15/72-003
 Flänsad slussventil
förberedd för manöverdon
Lång bygglängd DIN F5
 Segjärn
 EPDM gummibelagd kil
 Epoxibeläggning
 in- och utvändigt
 PN 10/16
 DN 40-500

Obs:
 * 400 mm genomlopp
 ** reducerat 400 mm genomlopp



AVK nr.	RSK nr.	DN	PN	Vikt	St/pall	Kod
15-050-70-016	4255744	50	10/16	15	24	C
15-065-72-016	4255745	65	10/16	18	17	C
15-080-72-016	4255746	80	10/16	22	14	C
15-100-72-016	4255747	100	10/16	28	12	C
15-150-72-016	4255749	150	10/16	52	8	C
15-200-72-006	4255750	200	10	73	6	C
15-250-72-006	4255751	250	10	121	4	C
15-300-72-006	4255752	300	10	171	2	C
15-350-72-006 *	4255753	350	10	332	2	C
15-400-72-006	4255754	400	10	353	2	C
15-500-72-006 **	4255756	500	10	430	1	C

Serie 636/00-008
 AVK Supa Maxi™ Slussventil
 med universala dragfasta
 kopplingar för alla rörtyper
 PN 16
 EPDM gummi
 Hus av segjärn



AVK nr.	RSK nr.	DN	Tolerans mm	PN	Vikt	St/pall	Kod
636-080-00-840064	4255429	80	082-106	16	15	8	A
636-100-00-840064	4255430	100	104-133	16	19	7	A
636-125-00-840064	4255431	125	132-159	16	23	6	A
636-150-00-840064	4255432	150	159-188	16	31	4	A
636-200-00-840064	4255433	200	193-227	16	52	4	A
636-205-00-840064	4255434	200	224-257	16	58	3	A
636-250-00-840064	4255435	250	266-301	16	92	2	A
636-300-00-840064	4255437	300	314-356	16	129	1	A

Serie 638/00-117 **NYHET**
 AVK Slussventil med Supa Maxi™
 koppling och PE-ända
 PN 16, SDR11
 EPDM gummi
 Hus av segjärn







AVK nr.	RSK nr.	DN	Tolerans mm	PE-rör	PN	Vikt	St/pall	Kod
638-090-00-866416099	4296910	80	82-106	Ø90	16	14	8	A
638-110-00-866416099	4296911	100	104-133	Ø110	16	20	7	A
638-125-00-866416099	4296912	125	104-133	Ø125	16	24	6	B
638-160-00-866416099	4296913	150	158-188	Ø160	16	37	4	A
638-200-00-866416099	4296914	200	193-227	Ø200	16	68	4	A
638-250-00-8664160	4296915	250	266-301	Ø250	16	118	2	B
638-315-00-8664160	4296916	300	314-356	Ø315	16	173	1	B

Serie 638/00-127 **NYHET**
 AVK Slussventil med Supa Maxi™
 koppling och PE-ända
 PN 10, SDR17
 EPDM gummi
 Hus av segjärn



AVK nr.	RSK nr.	DN	Tolerans mm	PE-rör	PN	Vikt	St/pall	Kod
638-090-00-866426099	4296917	80	82-106	Ø90	10	14	8	A
638-110-00-866426099	4296918	100	104-133	Ø110	10	20	7	A
638-125-00-866426099	4296919	125	104-133	Ø125	10	24	6	B
638-160-00-866426099	4296920	150	158-188	Ø160	10	37	4	A
638-200-00-866426099	4296921	200	193-227	Ø200	10	68	4	A
638-250-00-8664260	4296922	250	266-301	Ø250	10	118	2	B
638-315-00-8664260	4296923	300	314-356	Ø315	10	173	1	B

<p>Serie 32/40-018 Slussventil med långa slätändar för gjutjärnsrör Spindeladapter ingår Segjärn EPDM gummibelagd kil epoxibeläggning in- och utvändigt PN 16, DN 80-300</p> 	<table border="1"> <thead> <tr> <th>AVK nr.</th> <th>RSK nr.</th> <th>DN</th> <th>Utv Ø mm</th> <th>PN</th> <th>Vikt</th> <th>St/pall</th> <th>Kod</th> </tr> </thead> <tbody> <tr><td>32-080-40-814</td><td>4255155</td><td>80</td><td>98</td><td>16</td><td>16</td><td>20</td><td>A</td></tr> <tr><td>32-100-40-814</td><td>4255156</td><td>100</td><td>118</td><td>16</td><td>24</td><td>8</td><td>A</td></tr> <tr><td>32-150-40-814</td><td>4255157</td><td>150</td><td>170</td><td>16</td><td>45</td><td>6</td><td>A</td></tr> <tr><td>32-200-40-814</td><td>4255158</td><td>200</td><td>222</td><td>16</td><td>76</td><td>6</td><td>A</td></tr> <tr><td>32-250-40-814</td><td>4255159</td><td>250</td><td>274</td><td>16</td><td>121</td><td>4</td><td>A</td></tr> <tr><td>32-300-40-814</td><td>4255160</td><td>300</td><td>326</td><td>16</td><td>186</td><td>2</td><td>A</td></tr> </tbody> </table>	AVK nr.	RSK nr.	DN	Utv Ø mm	PN	Vikt	St/pall	Kod	32-080-40-814	4255155	80	98	16	16	20	A	32-100-40-814	4255156	100	118	16	24	8	A	32-150-40-814	4255157	150	170	16	45	6	A	32-200-40-814	4255158	200	222	16	76	6	A	32-250-40-814	4255159	250	274	16	121	4	A	32-300-40-814	4255160	300	326	16	186	2	A																																																																
AVK nr.	RSK nr.	DN	Utv Ø mm	PN	Vikt	St/pall	Kod																																																																																																																		
32-080-40-814	4255155	80	98	16	16	20	A																																																																																																																		
32-100-40-814	4255156	100	118	16	24	8	A																																																																																																																		
32-150-40-814	4255157	150	170	16	45	6	A																																																																																																																		
32-200-40-814	4255158	200	222	16	76	6	A																																																																																																																		
32-250-40-814	4255159	250	274	16	121	4	A																																																																																																																		
32-300-40-814	4255160	300	326	16	186	2	A																																																																																																																		
<p>Serie 01/70-010 Supa Plus™ slussventil Spindeladapter ingår dragfasta muffar för PVC- och PE-rör Segjärn EPDM gummibelagd kil Epoxibeläggning in- och utvändigt PN 16 DN 40-300</p> 	<table border="1"> <thead> <tr> <th>AVK nr.</th> <th>RSK nr.</th> <th>DN</th> <th>uPVC/PE Utv Ø mm</th> <th>PN</th> <th>Vikt</th> <th>St/pall</th> <th>Kod</th> </tr> </thead> <tbody> <tr><td>01-050-70-814</td><td>4255274</td><td>40</td><td>50</td><td>16</td><td>11</td><td>16</td><td>B</td></tr> <tr><td>01-063-70-814</td><td>4255275</td><td>50</td><td>63</td><td>16</td><td>12</td><td>12</td><td>B</td></tr> <tr><td>01-075-70-814</td><td>4255276</td><td>65</td><td>75</td><td>16</td><td>13</td><td>14</td><td>B</td></tr> <tr><td>01-090-70-8146499</td><td>4255277</td><td>80</td><td>90</td><td>16</td><td>17</td><td>17</td><td>B</td></tr> <tr><td>01-110-70-8146499</td><td>4255278</td><td>100</td><td>110</td><td>16</td><td>19</td><td>12</td><td>B</td></tr> <tr><td>01-125-70-8146499</td><td>4255279</td><td>125</td><td>125</td><td>16</td><td>24</td><td>9</td><td>B</td></tr> <tr><td>01-140-70-8146499</td><td>4255280</td><td>125</td><td>140</td><td>16</td><td>26</td><td>9</td><td>B</td></tr> <tr><td>01-160-70-8146499</td><td>4255281</td><td>150</td><td>160</td><td>16</td><td>33</td><td>9</td><td>B</td></tr> <tr><td>01-180-70-8146499</td><td>4255282</td><td>150</td><td>180</td><td>16</td><td>36</td><td>7</td><td>B</td></tr> <tr><td>01-200-70-8146499</td><td>4255283</td><td>200</td><td>200</td><td>16</td><td>53</td><td>6</td><td>B</td></tr> <tr><td>01-225-70-8146499</td><td>4255284</td><td>200</td><td>225</td><td>16</td><td>75</td><td>4</td><td>B</td></tr> <tr><td>01-250-70-814</td><td>4255285</td><td>250</td><td>250</td><td>16</td><td>103</td><td>4</td><td>B</td></tr> <tr><td>01-280-70-814</td><td>4255286</td><td>250</td><td>280</td><td>16</td><td>106</td><td>2</td><td>B</td></tr> <tr><td>01-315-70-814</td><td>4255287</td><td>300</td><td>315</td><td>16</td><td>143</td><td>2</td><td>B</td></tr> </tbody> </table>	AVK nr.	RSK nr.	DN	uPVC/PE Utv Ø mm	PN	Vikt	St/pall	Kod	01-050-70-814	4255274	40	50	16	11	16	B	01-063-70-814	4255275	50	63	16	12	12	B	01-075-70-814	4255276	65	75	16	13	14	B	01-090-70-8146499	4255277	80	90	16	17	17	B	01-110-70-8146499	4255278	100	110	16	19	12	B	01-125-70-8146499	4255279	125	125	16	24	9	B	01-140-70-8146499	4255280	125	140	16	26	9	B	01-160-70-8146499	4255281	150	160	16	33	9	B	01-180-70-8146499	4255282	150	180	16	36	7	B	01-200-70-8146499	4255283	200	200	16	53	6	B	01-225-70-8146499	4255284	200	225	16	75	4	B	01-250-70-814	4255285	250	250	16	103	4	B	01-280-70-814	4255286	250	280	16	106	2	B	01-315-70-814	4255287	300	315	16	143	2	B
AVK nr.	RSK nr.	DN	uPVC/PE Utv Ø mm	PN	Vikt	St/pall	Kod																																																																																																																		
01-050-70-814	4255274	40	50	16	11	16	B																																																																																																																		
01-063-70-814	4255275	50	63	16	12	12	B																																																																																																																		
01-075-70-814	4255276	65	75	16	13	14	B																																																																																																																		
01-090-70-8146499	4255277	80	90	16	17	17	B																																																																																																																		
01-110-70-8146499	4255278	100	110	16	19	12	B																																																																																																																		
01-125-70-8146499	4255279	125	125	16	24	9	B																																																																																																																		
01-140-70-8146499	4255280	125	140	16	26	9	B																																																																																																																		
01-160-70-8146499	4255281	150	160	16	33	9	B																																																																																																																		
01-180-70-8146499	4255282	150	180	16	36	7	B																																																																																																																		
01-200-70-8146499	4255283	200	200	16	53	6	B																																																																																																																		
01-225-70-8146499	4255284	200	225	16	75	4	B																																																																																																																		
01-250-70-814	4255285	250	250	16	103	4	B																																																																																																																		
01-280-70-814	4255286	250	280	16	106	2	B																																																																																																																		
01-315-70-814	4255287	300	315	16	143	2	B																																																																																																																		
<p>Serie 01/74-008 Supa Plus™ slussventil Spindeladapter ingår dragfasta muffar för PVC- och PE-rör Duplex spindel 1.4362 Segjärn EPDM gummibelagd kil Epoxibeläggning in- och utvändigt PN 16 DN 40-300</p> 	<table border="1"> <thead> <tr> <th>AVK nr.</th> <th>RSK nr.</th> <th>DN</th> <th>uPVC/PE Utv Ø mm</th> <th>PN</th> <th>Vikt</th> <th>St/pall</th> <th>Kod</th> </tr> </thead> <tbody> <tr><td>01-050-74-81464</td><td>4296721</td><td>40</td><td>50</td><td>16</td><td>11</td><td>16</td><td>B</td></tr> <tr><td>01-063-74-81464</td><td>4296722</td><td>50</td><td>63</td><td>16</td><td>12</td><td>12</td><td>B</td></tr> <tr><td>01-075-74-81464</td><td>4296723</td><td>65</td><td>75</td><td>16</td><td>13</td><td>14</td><td>B</td></tr> <tr><td>01-090-74-8146499</td><td>4296724</td><td>80</td><td>90</td><td>16</td><td>17</td><td>17</td><td>B</td></tr> <tr><td>01-110-74-8146499</td><td>4296725</td><td>100</td><td>110</td><td>16</td><td>19</td><td>12</td><td>B</td></tr> <tr><td>01-125-74-8146499</td><td>4296726</td><td>125</td><td>125</td><td>16</td><td>24</td><td>9</td><td>B</td></tr> <tr><td>01-140-74-8146499</td><td>4296727</td><td>125</td><td>140</td><td>16</td><td>26</td><td>9</td><td>B</td></tr> <tr><td>01-160-74-8146499</td><td>4296728</td><td>150</td><td>160</td><td>16</td><td>33</td><td>9</td><td>B</td></tr> <tr><td>01-180-74-8146499</td><td>4296729</td><td>150</td><td>180</td><td>16</td><td>36</td><td>7</td><td>B</td></tr> <tr><td>01-200-74-8146499</td><td>4296730</td><td>200</td><td>200</td><td>16</td><td>53</td><td>6</td><td>B</td></tr> <tr><td>01-225-74-8146499</td><td>4296731</td><td>200</td><td>225</td><td>16</td><td>75</td><td>4</td><td>B</td></tr> <tr><td>01-250-74-81464</td><td>4296732</td><td>250</td><td>250</td><td>16</td><td>103</td><td>4</td><td>B</td></tr> <tr><td>01-280-74-81464</td><td>4296733</td><td>250</td><td>280</td><td>16</td><td>106</td><td>2</td><td>B</td></tr> <tr><td>01-315-74-81464</td><td>4296734</td><td>300</td><td>315</td><td>16</td><td>143</td><td>2</td><td>B</td></tr> </tbody> </table>	AVK nr.	RSK nr.	DN	uPVC/PE Utv Ø mm	PN	Vikt	St/pall	Kod	01-050-74-81464	4296721	40	50	16	11	16	B	01-063-74-81464	4296722	50	63	16	12	12	B	01-075-74-81464	4296723	65	75	16	13	14	B	01-090-74-8146499	4296724	80	90	16	17	17	B	01-110-74-8146499	4296725	100	110	16	19	12	B	01-125-74-8146499	4296726	125	125	16	24	9	B	01-140-74-8146499	4296727	125	140	16	26	9	B	01-160-74-8146499	4296728	150	160	16	33	9	B	01-180-74-8146499	4296729	150	180	16	36	7	B	01-200-74-8146499	4296730	200	200	16	53	6	B	01-225-74-8146499	4296731	200	225	16	75	4	B	01-250-74-81464	4296732	250	250	16	103	4	B	01-280-74-81464	4296733	250	280	16	106	2	B	01-315-74-81464	4296734	300	315	16	143	2	B
AVK nr.	RSK nr.	DN	uPVC/PE Utv Ø mm	PN	Vikt	St/pall	Kod																																																																																																																		
01-050-74-81464	4296721	40	50	16	11	16	B																																																																																																																		
01-063-74-81464	4296722	50	63	16	12	12	B																																																																																																																		
01-075-74-81464	4296723	65	75	16	13	14	B																																																																																																																		
01-090-74-8146499	4296724	80	90	16	17	17	B																																																																																																																		
01-110-74-8146499	4296725	100	110	16	19	12	B																																																																																																																		
01-125-74-8146499	4296726	125	125	16	24	9	B																																																																																																																		
01-140-74-8146499	4296727	125	140	16	26	9	B																																																																																																																		
01-160-74-8146499	4296728	150	160	16	33	9	B																																																																																																																		
01-180-74-8146499	4296729	150	180	16	36	7	B																																																																																																																		
01-200-74-8146499	4296730	200	200	16	53	6	B																																																																																																																		
01-225-74-8146499	4296731	200	225	16	75	4	B																																																																																																																		
01-250-74-81464	4296732	250	250	16	103	4	B																																																																																																																		
01-280-74-81464	4296733	250	280	16	106	2	B																																																																																																																		
01-315-74-81464	4296734	300	315	16	143	2	B																																																																																																																		
<p>Serie 01/80-003 Slussventil med muff för PVC-rör Spindeladapter ingår monterad med "Euro"- gummiringar Segjärn EPDM gummibelagd kil Epoxibeläggning in- och utvändigt PN 16 DN 40-400</p> 	<table border="1"> <thead> <tr> <th>AVK nr.</th> <th>RSK nr.</th> <th>DN</th> <th>uPVC Utv Ø mm</th> <th>PN</th> <th>Vikt</th> <th>St/pall</th> <th>Kod</th> </tr> </thead> <tbody> <tr><td>01-050-80-814</td><td>4255007</td><td>40</td><td>50</td><td>16</td><td>7</td><td>24</td><td>B</td></tr> <tr><td>01-063-80-814</td><td>4255006</td><td>50</td><td>63</td><td>16</td><td>8</td><td>24</td><td>B</td></tr> <tr><td>01-075-80-814</td><td>4296479</td><td>65</td><td>75</td><td>16</td><td>9</td><td>19</td><td>B</td></tr> <tr><td>01-090-80-8146499</td><td>4255022</td><td>80</td><td>90</td><td>16</td><td>12</td><td>17</td><td>B</td></tr> <tr><td>01-110-80-8146499</td><td>4255030</td><td>100</td><td>110</td><td>16</td><td>15</td><td>12</td><td>B</td></tr> <tr><td>01-125-80-8146499</td><td>4255031</td><td>125</td><td>125</td><td>16</td><td>19</td><td>9</td><td>B</td></tr> <tr><td>01-160-80-8146499</td><td>4255048</td><td>150</td><td>160</td><td>16</td><td>29</td><td>7</td><td>B</td></tr> <tr><td>01-200-80-8146499</td><td>4296480</td><td>200</td><td>200</td><td>16</td><td>47</td><td>6</td><td>B</td></tr> <tr><td>01-225-80-8146499</td><td>4255063</td><td>200</td><td>225</td><td>16</td><td>50</td><td>6</td><td>B</td></tr> <tr><td>01-250-80-814</td><td>4296481</td><td>250</td><td>250</td><td>16</td><td>80</td><td>4</td><td>B</td></tr> <tr><td>01-280-80-814</td><td>4255089</td><td>250</td><td>280</td><td>16</td><td>95</td><td>4</td><td>B</td></tr> <tr><td>01-315-80-814</td><td>4255097</td><td>300</td><td>315</td><td>16</td><td>123</td><td>2</td><td>B</td></tr> <tr><td>01-400-80-814</td><td>4255105</td><td>400</td><td>400</td><td>16</td><td>246</td><td>2</td><td>B</td></tr> </tbody> </table>	AVK nr.	RSK nr.	DN	uPVC Utv Ø mm	PN	Vikt	St/pall	Kod	01-050-80-814	4255007	40	50	16	7	24	B	01-063-80-814	4255006	50	63	16	8	24	B	01-075-80-814	4296479	65	75	16	9	19	B	01-090-80-8146499	4255022	80	90	16	12	17	B	01-110-80-8146499	4255030	100	110	16	15	12	B	01-125-80-8146499	4255031	125	125	16	19	9	B	01-160-80-8146499	4255048	150	160	16	29	7	B	01-200-80-8146499	4296480	200	200	16	47	6	B	01-225-80-8146499	4255063	200	225	16	50	6	B	01-250-80-814	4296481	250	250	16	80	4	B	01-280-80-814	4255089	250	280	16	95	4	B	01-315-80-814	4255097	300	315	16	123	2	B	01-400-80-814	4255105	400	400	16	246	2	B								
AVK nr.	RSK nr.	DN	uPVC Utv Ø mm	PN	Vikt	St/pall	Kod																																																																																																																		
01-050-80-814	4255007	40	50	16	7	24	B																																																																																																																		
01-063-80-814	4255006	50	63	16	8	24	B																																																																																																																		
01-075-80-814	4296479	65	75	16	9	19	B																																																																																																																		
01-090-80-8146499	4255022	80	90	16	12	17	B																																																																																																																		
01-110-80-8146499	4255030	100	110	16	15	12	B																																																																																																																		
01-125-80-8146499	4255031	125	125	16	19	9	B																																																																																																																		
01-160-80-8146499	4255048	150	160	16	29	7	B																																																																																																																		
01-200-80-8146499	4296480	200	200	16	47	6	B																																																																																																																		
01-225-80-8146499	4255063	200	225	16	50	6	B																																																																																																																		
01-250-80-814	4296481	250	250	16	80	4	B																																																																																																																		
01-280-80-814	4255089	250	280	16	95	4	B																																																																																																																		
01-315-80-814	4255097	300	315	16	123	2	B																																																																																																																		
01-400-80-814	4255105	400	400	16	246	2	B																																																																																																																		
<p>Serie 01/86-001 Slussventil med muff för PVC-rör Spindeladapter ingår monterad med "Euro"- gummiringar Duplex spindel 1.4362 Segjärn EPDM gummibelagd kil Epoxibeläggning in- och utvändigt PN 16 DN 40-400</p> 	<table border="1"> <thead> <tr> <th>AVK nr.</th> <th>RSK nr.</th> <th>DN</th> <th>uPVC Utv Ø mm</th> <th>PN</th> <th>Vikt</th> <th>St/pall</th> <th>Kod</th> </tr> </thead> <tbody> <tr><td>01-050-86-81464</td><td>4296735</td><td>40</td><td>50</td><td>16</td><td>7</td><td>24</td><td>B</td></tr> <tr><td>01-063-86-81464</td><td>4296736</td><td>50</td><td>63</td><td>16</td><td>8</td><td>24</td><td>B</td></tr> <tr><td>01-075-86-81464</td><td>4296737</td><td>65</td><td>75</td><td>16</td><td>9</td><td>19</td><td>B</td></tr> <tr><td>01-090-86-8146499</td><td>4296738</td><td>80</td><td>90</td><td>16</td><td>12</td><td>17</td><td>B</td></tr> <tr><td>01-110-86-8146499</td><td>4296739</td><td>100</td><td>110</td><td>16</td><td>15</td><td>12</td><td>B</td></tr> <tr><td>01-125-86-8146499</td><td>4296740</td><td>125</td><td>125</td><td>16</td><td>19</td><td>9</td><td>B</td></tr> <tr><td>01-160-86-8146499</td><td>4296741</td><td>150</td><td>160</td><td>16</td><td>29</td><td>7</td><td>B</td></tr> <tr><td>01-200-86-8146499</td><td>4296742</td><td>200</td><td>200</td><td>16</td><td>47</td><td>6</td><td>B</td></tr> <tr><td>01-225-86-8146499</td><td>4296743</td><td>200</td><td>225</td><td>16</td><td>50</td><td>6</td><td>B</td></tr> <tr><td>01-250-86-81464</td><td>4296744</td><td>250</td><td>250</td><td>16</td><td>80</td><td>4</td><td>B</td></tr> <tr><td>01-280-86-81464</td><td>4296745</td><td>250</td><td>280</td><td>16</td><td>95</td><td>4</td><td>B</td></tr> <tr><td>01-315-86-81464</td><td>4296746</td><td>300</td><td>315</td><td>16</td><td>123</td><td>2</td><td>B</td></tr> <tr><td>01-400-86-81464</td><td>4296747</td><td>400</td><td>400</td><td>16</td><td>246</td><td>2</td><td>B</td></tr> </tbody> </table>	AVK nr.	RSK nr.	DN	uPVC Utv Ø mm	PN	Vikt	St/pall	Kod	01-050-86-81464	4296735	40	50	16	7	24	B	01-063-86-81464	4296736	50	63	16	8	24	B	01-075-86-81464	4296737	65	75	16	9	19	B	01-090-86-8146499	4296738	80	90	16	12	17	B	01-110-86-8146499	4296739	100	110	16	15	12	B	01-125-86-8146499	4296740	125	125	16	19	9	B	01-160-86-8146499	4296741	150	160	16	29	7	B	01-200-86-8146499	4296742	200	200	16	47	6	B	01-225-86-8146499	4296743	200	225	16	50	6	B	01-250-86-81464	4296744	250	250	16	80	4	B	01-280-86-81464	4296745	250	280	16	95	4	B	01-315-86-81464	4296746	300	315	16	123	2	B	01-400-86-81464	4296747	400	400	16	246	2	B								
AVK nr.	RSK nr.	DN	uPVC Utv Ø mm	PN	Vikt	St/pall	Kod																																																																																																																		
01-050-86-81464	4296735	40	50	16	7	24	B																																																																																																																		
01-063-86-81464	4296736	50	63	16	8	24	B																																																																																																																		
01-075-86-81464	4296737	65	75	16	9	19	B																																																																																																																		
01-090-86-8146499	4296738	80	90	16	12	17	B																																																																																																																		
01-110-86-8146499	4296739	100	110	16	15	12	B																																																																																																																		
01-125-86-8146499	4296740	125	125	16	19	9	B																																																																																																																		
01-160-86-8146499	4296741	150	160	16	29	7	B																																																																																																																		
01-200-86-8146499	4296742	200	200	16	47	6	B																																																																																																																		
01-225-86-8146499	4296743	200	225	16	50	6	B																																																																																																																		
01-250-86-81464	4296744	250	250	16	80	4	B																																																																																																																		
01-280-86-81464	4296745	250	280	16	95	4	B																																																																																																																		
01-315-86-81464	4296746	300	315	16	123	2	B																																																																																																																		
01-400-86-81464	4296747	400	400	16	246	2	B																																																																																																																		

Serie 18/70-005

Kombikors
4-vägs
Segjärn
EPDM gummibelagd kil
Epoxibeläggning
in- och utvändigt
PN 10/16
DN 100-300



Spindeladapter ingår ej

AVK nr.	RSK nr.	DN	PN	Vikt	St/pall	Kod
18-100-70-01600210	4417184	100	10/16	119	2	B
18-150-70-01600210	4417185	150	10/16	190	1	B
18-200-70-00600210	4417186	200	10	316	1	B
18-200-70-01600210	4417187	200	16	316	1	B
18-250-70-00600210	4417188	250	10	520	1	B
18-300-70-00600210	4417190	300	10	690	1	B

Serie 18/80-005

Kombikors
3-vägs
Segjärn
EPDM gummibelagd kil
Epoxibeläggning
in- och utvändigt
PN 10/16
DN 100-300



AVK nr.	RSK nr.	DN	PN	Vikt	St/pall	Kod
18-100-80-01600210	4417208	100	10/16	90	3	B
18-150-80-01600210	4417209	150	10/16	165	2	B
18-200-80-00600210	4417210	200	10	280	1	B
18-200-80-01600210	4417211	200	16	280	1	B
18-250-80-00600210	4417212	250	10	450	1	B
18-300-80-00600210	4417214	300	10	620	1	B

Serie 18/40-003

Kombi-T med flänsar
Segjärn
EPDM gummibelagd kil
Epoxibeläggning
in- och utvändigt
PN 10/16
DN 80-100



AVK nr.	RSK nr.	DN	PN	Vikt	St/pall	Kod
18-080-40-016	4417078	80/80	10/16	24	8	B
18-080-41-016	4417079	80/100	10/16	26	8	B
18-100-40-016	4417080	100/100	10/16	31	8	B
18-100-43-016	4417081	100/150	10/16	37	6	B
18-100-44-016	4417082	100/200	10	43	4	B



GARNITYR FÖR SLUSSVENTILER DN 50-600

Serie 04/09-001

Teleskopiskt garnityr för slussventiler

Galvat

Standard
DN 50-400
Fyrkant 23-32 mm



AVK nr.	RSK nr.	DN	Spindel- fyrkant mm	Längd mm	Vikt	St/pall	Kod
04-315-4-0002	4260286	50-400	23-32	450-700	2,6	45	A
04-315-4-0502	4260287	50-400	23-32	650-1100	2,6	45	A
04-315-4-1002	4260288	50-400	23-32	1050-1750	2,6	30	A
04-315-4-1202	4260289	50-400	23-32	1400-2350	2,6	40	A
04-315-4-1502	4260290	50-400	23-32	1700-2900	7,6	30	A
04-315-4-2002	4260296	50-400	23-32	2500-4700	9,5	30	A

Serie 04

Teleskopiskt garnityr för slussventiler

Rostfritt AISI 304

Standard
DN 50-400
Fyrkant 23-32 mm



AVK nr.	RSK nr.	DN	Spindel- fyrkant mm	Längd mm	Vikt	St/pall	Kod
04-315-4-000202	4260291	50-400	23-32	450-700	2,56	45	A
04-315-4-050202	4260292	50-400	23-32	650-1100	3,4	45	A
04-315-4-100202	4260293	50-400	23-32	1050-1750	2,6	30	A
04-315-4-120202	4260294	50-400	23-32	1400-2350	2,6	40	A
04-315-4-150202	4260295	50-400	23-32	1700-2900	7,6	30	A
04-315-4-200202	4260297	50-400	23-32	2500-4700	9,5	30	A

Serie 04

Teleskopiskt garnityr för slussventiler

Galvat

Standard
DN 450-600
Fyrkant 23-32 mm

Ø30 mm bottenadapter



AVK nr.	RSK nr.	DN	Spindel- fyrkant mm	Längd mm	Vikt	St/pall	Kod
04-630-4-0002	4260330	450-600	23-32	450-700	2,6	24	B
04-630-4-0502	4260331	450-600	23-32	650-1100	3,4	24	B
04-630-4-1002	4260332	450-600	23-32	1050-1750	4,5	30	C
04-630-4-1502	4260333	450-600	23-32	1700-2900	7,6	24	C
04-630-4-2202		450-600	23-32	2850-5250	11		C

Serie 04

Teleskopiskt garnityr för slussventiler

Rostfritt AISI 304

Standard
DN 450-600
Fyrkant 23-32 mm

Ø30 mm bottenadapter



NYHET

AVK nr.	RSK nr.	DN	Spindel- fyrkant mm	Längd mm	Vikt	St/pall	Kod
04-830-4-000202	4219686	450-600	23-32	450-600	4,8	24	B
04-830-4-050202	4219687	450-600	23-32	600-950	5,4	24	B
04-830-4-100202	4219688	450-600	23-32	900-1750	6,6	30	B
04-830-4-120202	4219689	450-600	23-32	1500-2750	9,1	24	B
04-830-4-150202	4219690	450-600	23-32	1700-2900	9,5	12	B
04-830-4-220202	4219691	450-600	23-32	2700-5150	14,2	12	B

Serie 756/100-104

Dubbelcentrisk vridspjällventil med handratt
Serie 14 (F4) med växel och handratt
Hus, klaff och packningsring i segjärn
Spindel i rostfritt stål
Epoxibeläggning in- och utvändigt
PN 10/16
DN 200-600
Min GGG-40



AVK nr.	RSK nr.	DN	PN	Vikt	St/pall	Kod
756-0200-1-04	4564339	200	10	51	4	B
756-0250-1-04	4564340	250	10	71	3	B
756-0300-1-04	4564341	300	10	100	2	B
756-0350-1-04	4564342	350	10	128	2	B
756-0400-1-04	4564343	400	10	166	1	B
756-0450-1-04	4564344	450	10	211	1	B
756-0500-1-04	4564345	500	10	206	1	B
756-0600-1-04	4564346	600	10	285	1	B

AVK nr.	RSK nr.	DN	PN	Vikt	St/pall	Kod
756-0200-1-14	4566029	200	16	51	4	B
756-0250-1-14	4566030	250	16	71	3	B
756-0300-1-14	4566031	300	16	106	2	B
756-0350-1-14	4566032	350	16	134	2	B
756-0400-1-14	4566033	400	16	166	1	B
756-0450-1-14	4566034	450	16	219	1	B
756-0500-1-14	4566035	500	16	282	1	B
756-0600-1-14	4566036	600	16	426	1	B

Serie 756/106-146

Dubbelcentrisk vridspjällventil för nedgrävning
Serie 14 (F4) med växel för direkt nedgrävning IP68
Hus, klaff och packningsring i segjärn
Spindel i rostfritt stål
Epoxibeläggning in- och utvändigt
PN 10/16
DN 200-600
Min GGG-40



AVK nr.	RSK nr.	DN	PN	Vikt	St/pall	Kod
756-0200-1-04006	4564347	200	10	40	4	B
756-0250-1-04006	4564348	250	10	58	3	B
756-0300-1-04006	4564349	300	10	83	2	B
756-0350-1-04006	4564350	350	10	110	2	B
756-0400-1-04006	4564351	400	10	142	1	B
756-0450-1-04006	4564352	450	10	184	1	B
756-0500-1-04006	4564353	500	10	240	1	B
756-0600-1-04006	4564354	600	10	410	1	B

AVK nr.	RSK nr.	DN	PN	Vikt	St/pall	Kod
756-0200-1-14006	4566037	200	16	51	4	B
756-0250-1-14006	4566038	250	16	50	3	B
756-0300-1-14006	4566039	300	16	106	2	B
756-0350-1-14006	4566040	350	16	172	2	B
756-0400-1-14006	4566041	400	16	166	1	B
756-0450-1-14006	4566042	450	16	214	1	B
756-0500-1-14006	4566043	500	16	214	1	B
756-0600-1-14006	4566044	600	16	425	1	B

Serie 756/102-142

Dubbelcentrisk vridspjällventil för manöverdon
Serie 14 (F4) med ISO-flänsad växel
Hus, klaff och packningsring i segjärn
Spindel i rostfritt stål
Epoxibeläggning in- och utvändigt
PN 10/16
DN 200-600
Min GGG-40



AVK nr.	RSK nr.	DN	PN	Vikt	St/pall	Kod
756-0200-1-04002	4564355	200	10	40	4	B
756-0250-1-04002	4564356	250	10	58	3	B
756-0300-1-04002	4564357	300	10	83	2	B
756-0350-1-04002	4564358	350	10	110	2	B
756-0400-1-04002	4564359	400	10	142	1	B
756-0450-1-04002	4564360	450	10	184	1	B
756-0500-1-04002	4564361	500	10	240	1	B
756-0600-1-04002	4564362	600	10	410	1	B

AVK nr.	RSK nr.	DN	PN	Vikt	St/pall	Kod
756-0200-1-14002	4566045	200	16	40	4	B
756-0250-1-14002	4566046	250	16	68	3	B
756-0300-1-14002	4566047	300	16	83	2	B
756-0350-1-14002	4566048	350	16	110	2	B
756-0400-1-14002	4566049	400	16	166	1	B
756-0450-1-14002	4566050	450	16	184	1	B
756-0500-1-14002	4566051	500	16	240	1	B
756-0600-1-14002	4566052	600	16	410	1	B

Serie 756/106-682

Dubbelcentrisk vridspjällventil för slitande media
Serie 14 (F4) med växel för direkt nedgrävning IP68
mjuktätande packning
Hus, klaff och packningsring i segjärn
Spindel i rostfritt stål
Säte av rostfritt stål
PN 10
DN 700-1200
Min GGG-40



AVK nr.	RSK nr.	DN	PN	Vikt	St/pall	Kod
756-0700-1-0400609	4656040	700	10	444	1	B
756-0800-1-0400609	4656041	800	10	592	1	B
756-0900-1-0400609	4656042	900	10	745	1	C
756-1000-1-0400609	4656043	1000	10	974	1	B
756-1200-1-0400609	4656044	1200	10	1442	1	B



GARNITYR FÖR DUBBELEX. VRIDSPJÄLL SERIE 756

Serie 756/7-001

Teleskopisks garnityr för vridspjällsventiler
Betjäningsfyrkant i svensk standard
Invändigt rör i galvaniserat stål



AVK nr.	RSK nr.	DN	mm	Vikt	St/pall	Kod
04-400-9-0002 ¹	4260528	Se not.	450-700	3,4	30	A
04-400-9-0502 ¹	4260529	Se not.	650-1100	4	40	A
04-400-9-1002 ¹	4260530	Se not.	1050-1750	4,7	44	A
04-400-9-1502 ¹	4260531	Se not.	1700-2900	5,2	55	A
04-400-9-2202 ¹	4219692	Se not.	2850-5250	11	30	

AVK nr.	RSK nr.	DN	Längd	Vikt	St/pall	Kod
04-600-9-0002 ²	4260532	Se not.	450-700	3,6	30	A
04-600-9-0502 ²	4260533	Se not.	650-1100	6	40	B
04-600-9-1002 ²	4260534	Se not.	1050-1750	4,9	44	B
04-600-9-1502 ²	4260535	Se not.	1700-2900	5,9	55	B
04-600-9-2202 ²	4219693	Se not.	2850-5250	11,5	30	B

¹ För DN200-DN500 PN10/16, DN600 PN10. Växelns spindel är Ø20 mm och omkring 115 mm hög

² För DN600 PN16, DN700-DN1200 PN10/16. Växelns spindel är Ø20 mm och omkring 165 mm hög

Serie 04X

Visarverk av plast för dubbelexcentriska vridspjäll.
Klarar upp till 81 varv



Visarverk av aluminium för dubbelexcentriska vridspjäll.
Finns med 13, 47, 140, 470 och 1505 max varv

Innesälj hjälper med val av visarverk

AVK nr.	RSK nr.	Typ	Max varv	Fyrkant	Vikt	Kod
970400403513931	3481668	Visarverk	81	#19	0,2	C

AVK nr.	RSK nr.	Typ	Max varv	Fyrkant	Vikt	Kod
97040040351391019	3481669	Visarverk	13	#19	1,7	C
97040040351390919	3481670	Visarverk	47	#19	1,7	C
97040040351390719	3481671	Visarverk	140	#19	1,7	C
97040040351390819	3481672	Visarverk	470	#19	1,7	C
97040040351391819	3481673	Visarverk	1505	#19	1,7	C

Serie 04



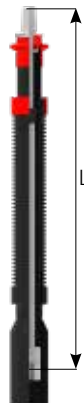

Teleskopiskt garnityr förberedda för visarverk till dubbelexcentriska vridspjäll.
Visarverk ska alltid beställas samtidigt med garnityret.
Betjäningsfyrkant enligt svensk standard 23/32.
Invändigt rör i galvaniserat stål.



AVK nr.	RSK nr.	Typ	Längd mm	Spindel-Fyrkant	Ø mm	Vikt	Kod
97040040357100020Z ¹	4219567	Garnityr	960-1450	23/32	20	5,5	C
97040040357100120Z ¹	4219568	Garnityr	980-1760	23/32	20	6,1	C
97040040357100220Z ¹	4219569	Garnityr	1660-2660	23/32	20	7,3	C
97040040357100320Z ¹	4219570	Garnityr	2460-2980	23/32	20	9,4	C
97040040357100025Z ²	4219571	Garnityr	960-1450	23/32	20	5,5	C
97040040357100125Z ²	4219572	Garnityr	980-1760	23/32	20	6,1	C
97040040357100225Z ²	4219573	Garnityr	1660-2660	23/32	20	7,3	C
97040040357100325Z ²	4219574	Garnityr	2460-2980	23/32	20	9,4	C

¹ För DN200-DN500 PN10/16, DN600 PN10. Växelns spindel är Ø20 mm och omkring 115 mm hög

² För DN600 PN16, DN700-DN1200 PN10/16. Växelns spindel är Ø20 mm och omkring 165 mm hög

<p>Serie 820/60-060 Centrisk vridspjällsventil Luggad Dricksvattengodkänt EPDM-gummi Rostfri spjällskiva och axel Epoxymålad med 200 µm Handspak beställs separat Från DN 200 ska man beställa växlar med ratt Hus av segjärn DN 25-300</p> 	<table border="1"> <thead> <tr> <th>AVK nr.</th> <th>DN</th> <th>PN</th> <th>Vikt</th> <th>Kod</th> </tr> </thead> <tbody> <tr><td>820-0040-60-04020160002</td><td>40</td><td>10/16</td><td>2,3</td><td>B</td></tr> <tr><td>820-0050-60-041L0160002</td><td>50</td><td>10/16</td><td>3,5</td><td>A</td></tr> <tr><td>820-0065-60-041L0160002</td><td>65</td><td>10/16</td><td>4,5</td><td>A</td></tr> <tr><td>820-0080-60-041L0160002</td><td>80</td><td>10/16</td><td>6,5</td><td>A</td></tr> <tr><td>820-0100-60-041L0160002</td><td>100</td><td>10/16</td><td>8</td><td>A</td></tr> <tr><td>820-0125-60-041L0160002</td><td>125</td><td>10/16</td><td>11</td><td>A</td></tr> <tr><td>820-0150-60-041L0160002</td><td>150</td><td>10/16</td><td>12</td><td>A</td></tr> <tr><td>820-0200-60-041L0030002</td><td>200</td><td>10</td><td>18,7</td><td>A</td></tr> <tr><td>820-0250-60-041L0030002</td><td>250</td><td>10</td><td>22,1</td><td>A</td></tr> <tr><td>820-0300-60-041L0030002</td><td>300</td><td>10</td><td>32</td><td>A</td></tr> <tr><td>820-0350-60-04020030002</td><td>350</td><td>10</td><td>55</td><td>A</td></tr> <tr><td>820-0400-60-04020030002</td><td>400</td><td>10</td><td>75</td><td>A</td></tr> </tbody> </table>	AVK nr.	DN	PN	Vikt	Kod	820-0040-60-04020160002	40	10/16	2,3	B	820-0050-60-041L0160002	50	10/16	3,5	A	820-0065-60-041L0160002	65	10/16	4,5	A	820-0080-60-041L0160002	80	10/16	6,5	A	820-0100-60-041L0160002	100	10/16	8	A	820-0125-60-041L0160002	125	10/16	11	A	820-0150-60-041L0160002	150	10/16	12	A	820-0200-60-041L0030002	200	10	18,7	A	820-0250-60-041L0030002	250	10	22,1	A	820-0300-60-041L0030002	300	10	32	A	820-0350-60-04020030002	350	10	55	A	820-0400-60-04020030002	400	10	75	A
AVK nr.	DN	PN	Vikt	Kod																																																														
820-0040-60-04020160002	40	10/16	2,3	B																																																														
820-0050-60-041L0160002	50	10/16	3,5	A																																																														
820-0065-60-041L0160002	65	10/16	4,5	A																																																														
820-0080-60-041L0160002	80	10/16	6,5	A																																																														
820-0100-60-041L0160002	100	10/16	8	A																																																														
820-0125-60-041L0160002	125	10/16	11	A																																																														
820-0150-60-041L0160002	150	10/16	12	A																																																														
820-0200-60-041L0030002	200	10	18,7	A																																																														
820-0250-60-041L0030002	250	10	22,1	A																																																														
820-0300-60-041L0030002	300	10	32	A																																																														
820-0350-60-04020030002	350	10	55	A																																																														
820-0400-60-04020030002	400	10	75	A																																																														
<p>Serie 820/60-080 Centrisk vridspjällsventil Luggad Dricksvattengodkänt NBR-gummi Rostfri spjällskiva och axel Epoxymålad med 200 µm Handspak beställs separat Från DN 200 ska man beställa växlar med ratt Hus av segjärn DN 25-300</p> 	<table border="1"> <thead> <tr> <th>AVK nr.</th> <th>DN</th> <th>PN</th> <th>Vikt</th> <th>Kod</th> </tr> </thead> <tbody> <tr><td>820-0080-60-031L0160002</td><td>80</td><td>10/16</td><td>6,5</td><td>B</td></tr> <tr><td>820-0100-60-031L0160002</td><td>100</td><td>10/16</td><td>8</td><td>C</td></tr> <tr><td>820-0125-60-03020160002</td><td>125</td><td>10/16</td><td>11</td><td>C</td></tr> <tr><td>820-0150-60-031L0160002</td><td>150</td><td>10/16</td><td>12</td><td>C</td></tr> <tr><td>820-0200-60-031L0030002</td><td>200</td><td>10</td><td>18,7</td><td>C</td></tr> <tr><td>820-0250-60-03020030002</td><td>250</td><td>10</td><td>22,1</td><td>C</td></tr> </tbody> </table>	AVK nr.	DN	PN	Vikt	Kod	820-0080-60-031L0160002	80	10/16	6,5	B	820-0100-60-031L0160002	100	10/16	8	C	820-0125-60-03020160002	125	10/16	11	C	820-0150-60-031L0160002	150	10/16	12	C	820-0200-60-031L0030002	200	10	18,7	C	820-0250-60-03020030002	250	10	22,1	C																														
AVK nr.	DN	PN	Vikt	Kod																																																														
820-0080-60-031L0160002	80	10/16	6,5	B																																																														
820-0100-60-031L0160002	100	10/16	8	C																																																														
820-0125-60-03020160002	125	10/16	11	C																																																														
820-0150-60-031L0160002	150	10/16	12	C																																																														
820-0200-60-031L0030002	200	10	18,7	C																																																														
820-0250-60-03020030002	250	10	22,1	C																																																														
<p>Serie 820/50-060 Centrisk vridspjällsventil Wafer typ Dricksvattengodkänt EPDM-gummi Rostfri spjällskiva och axel Epoxymålad med 200 µm Handspak beställs separat Från DN 200 ska man beställa växlar med ratt Hus av gjutjärn DN 25-300</p> 	<table border="1"> <thead> <tr> <th>AVK nr.</th> <th>DN</th> <th>PN</th> <th>Vikt</th> <th>Kod</th> </tr> </thead> <tbody> <tr><td>820-0050-50-041L0160002</td><td>50</td><td>10/16</td><td>3,5</td><td>A</td></tr> <tr><td>820-0065-50-041L0160002</td><td>65</td><td>10/16</td><td>3,6</td><td>A</td></tr> <tr><td>820-0080-50-04020160002</td><td>80</td><td>10/16</td><td>6,5</td><td>A</td></tr> <tr><td>820-0100-50-041L0160002</td><td>100</td><td>10/16</td><td>5,6</td><td>A</td></tr> <tr><td>820-0125-50-041L0160002</td><td>125</td><td>10/16</td><td>5,6</td><td>A</td></tr> <tr><td>820-0150-50-041L0160002</td><td>150</td><td>10/16</td><td>8,4</td><td>A</td></tr> <tr><td>820-0200-50-041L0030002</td><td>200</td><td>10</td><td>18,7</td><td>C</td></tr> <tr><td>820-0250-50-04020030002</td><td>250</td><td>10</td><td>22,1</td><td>C</td></tr> <tr><td>820-0300-50-04020030002</td><td>300</td><td>10</td><td>32</td><td>C</td></tr> <tr><td>820-0350-50-04020030002</td><td>350</td><td>10</td><td>55</td><td>C</td></tr> <tr><td>820-0400-50-04020030002</td><td>400</td><td>10</td><td>75</td><td>C</td></tr> </tbody> </table>	AVK nr.	DN	PN	Vikt	Kod	820-0050-50-041L0160002	50	10/16	3,5	A	820-0065-50-041L0160002	65	10/16	3,6	A	820-0080-50-04020160002	80	10/16	6,5	A	820-0100-50-041L0160002	100	10/16	5,6	A	820-0125-50-041L0160002	125	10/16	5,6	A	820-0150-50-041L0160002	150	10/16	8,4	A	820-0200-50-041L0030002	200	10	18,7	C	820-0250-50-04020030002	250	10	22,1	C	820-0300-50-04020030002	300	10	32	C	820-0350-50-04020030002	350	10	55	C	820-0400-50-04020030002	400	10	75	C					
AVK nr.	DN	PN	Vikt	Kod																																																														
820-0050-50-041L0160002	50	10/16	3,5	A																																																														
820-0065-50-041L0160002	65	10/16	3,6	A																																																														
820-0080-50-04020160002	80	10/16	6,5	A																																																														
820-0100-50-041L0160002	100	10/16	5,6	A																																																														
820-0125-50-041L0160002	125	10/16	5,6	A																																																														
820-0150-50-041L0160002	150	10/16	8,4	A																																																														
820-0200-50-041L0030002	200	10	18,7	C																																																														
820-0250-50-04020030002	250	10	22,1	C																																																														
820-0300-50-04020030002	300	10	32	C																																																														
820-0350-50-04020030002	350	10	55	C																																																														
820-0400-50-04020030002	400	10	75	C																																																														
<p>Serie 174XHL Handspak till Centrisk vridspjällsventil Plast Låsbar i steg om 10°</p> 	<table border="1"> <thead> <tr> <th>AVK nr.</th> <th>DN</th> <th>Vikt</th> <th>Kod</th> </tr> </thead> <tbody> <tr><td>174XHLPAA001</td><td>50-100</td><td>1,1</td><td>A</td></tr> <tr><td>174XHLPAA002</td><td>125-150</td><td>1,2</td><td>A</td></tr> <tr><td>174XHLPAA003</td><td>200</td><td>1,2</td><td>A</td></tr> </tbody> </table>	AVK nr.	DN	Vikt	Kod	174XHLPAA001	50-100	1,1	A	174XHLPAA002	125-150	1,2	A	174XHLPAA003	200	1,2	A																																																	
AVK nr.	DN	Vikt	Kod																																																															
174XHLPAA001	50-100	1,1	A																																																															
174XHLPAA002	125-150	1,2	A																																																															
174XHLPAA003	200	1,2	A																																																															
<p>Serie GB232 Snäckväxel med ratt till Centrisk vridspjällsventil Aluminium Visuell lägesvisare</p> 	<table border="1"> <thead> <tr> <th>AVK nr.</th> <th>DN</th> <th>Vikt</th> <th>Kod</th> </tr> </thead> <tbody> <tr><td>GB23205.F050711.10</td><td>50-100</td><td>0,8</td><td>A</td></tr> <tr><td>GB23205.F050714.10</td><td>125</td><td>0,9</td><td>A</td></tr> <tr><td>GB23206.F050714.16</td><td>150</td><td>0,8</td><td>A</td></tr> <tr><td>GB23206.F050717.16</td><td>200</td><td>0,9</td><td>A</td></tr> <tr><td>GB23208.F071022.25</td><td>250-300</td><td>1,5</td><td>A</td></tr> <tr><td>GB23213.F101222.40</td><td>350</td><td>7</td><td>A</td></tr> <tr><td>GB880N.F1227.60-S</td><td>400</td><td>14</td><td>C</td></tr> </tbody> </table>	AVK nr.	DN	Vikt	Kod	GB23205.F050711.10	50-100	0,8	A	GB23205.F050714.10	125	0,9	A	GB23206.F050714.16	150	0,8	A	GB23206.F050717.16	200	0,9	A	GB23208.F071022.25	250-300	1,5	A	GB23213.F101222.40	350	7	A	GB880N.F1227.60-S	400	14	C																																	
AVK nr.	DN	Vikt	Kod																																																															
GB23205.F050711.10	50-100	0,8	A																																																															
GB23205.F050714.10	125	0,9	A																																																															
GB23206.F050714.16	150	0,8	A																																																															
GB23206.F050717.16	200	0,9	A																																																															
GB23208.F071022.25	250-300	1,5	A																																																															
GB23213.F101222.40	350	7	A																																																															
GB880N.F1227.60-S	400	14	C																																																															

Serie 79-001

Flänspackning med stålkärna
Stål
EPDM gummi
rak "KGS" design
PN 10-40 / 10/16 / 10
DN 50-800



AVK nr.	RSK nr.	DN	Dimension	Vikt	St/bunt	Kod
79-050-4-42	1508101	50	107 x 61 x 4 mm	0,034	20	A
79-065-4-42	1508102	65	127 x 77 x 4 mm	0,045	20	A
79-080-4-42	1508103	80	142 x 89 x 4 mm	0,069	20	A
79-100-4-22	1508104	100	162 x 115 x 5 mm	0,080	20	A
79-125-4-22	1508105	125	192 x 141 x 5 mm	0,106	20	A
79-150-4-22	1508106	150	218 x 169 x 5 mm	0,122	20	A
79-200-4-22	1508107	200	273 x 220 x 6 mm	0,180	20	A
79-250-4-12	1508108	250	328 x 273 x 6 mm	0,260	20	A
79-300-4-12	1508109	300	378 x 324 x 6 mm	0,300	20	A
79-350-4-12	1508110	350	438x 356 x 7 mm	0,480	10	B
79-400-4-12	1508111	400	489 x 407 x 7 mm	0,740	10	A
79-450-4-12	1508112	450	539 x 458 x 7 mm	0,950	10	C
79-500-4-12	1508113	500	594 x 508 x 7 mm	1,000	10	A
79-600-4-12	1508114	600	695 x 610 x 7 mm	1,060	10	A
79-700-4-12	1508115	700	810 x 712 x 8 mm	1,500	10	B
79-800-4-12	1508116	800	820 x 813 x 8 mm	2,160	10	B

Serie 79-003

Flänspackning med stålkärna
Stål
EPDM gummi
drop-formad "KGS-S" design
PN 10-40 / 10/16 / 10
DN 50-800



AVK nr.	RSK nr.	DN	Dimension	Vikt	St/bunt	Kod
79-050-4-43	1508136	50	107 x 61 x 4 mm	0,034	20	B
79-065-4-43	1508137	65	127 x 77 x 4 mm	0,045	20	B
79-080-4-43	1508138	80	142 x 89 x 4 mm	0,069	20	B
79-100-4-23	1508139	100	162 x 115 x 5 mm	0,080	20	B
79-125-4-23	1508140	125	192 x 141 x 5 mm	0,106	20	B
79-150-4-23	1508141	150	218 x 169 x 5 mm	0,122	20	B
79-200-4-23	1508143	200	273 x 220 x 6 mm	0,180	20	B
79-250-4-13	1508144	250	328 x 273 x 6 mm	0,260	20	B
79-300-4-13	1508145	300	378 x 324 x 6 mm	0,300	20	B
79-350-4-13	1508146	350	438x 356 x 7 mm	0,480	10	B
79-400-4-13	1508147	400	489 x 407 x 7 mm	0,740	10	B
79-450-4-13	1508148	450	539 x 458 x 7 mm	0,950	10	B
79-500-4-13	1508149	500	594 x 508 x 7 mm	1,000	10	B
79-600-4-13	1508150	600	695 x 610 x 7 mm	1,060	10	B
79-700-4-13	1508151	700	810 x 712 x 8 mm	1,500	10	B
79-800-4-13	1508152	800	820 x 813 x 8 mm	2,160	10	B

<p>Serie 04/008-001 Betäckning i segjärn för AVK teleskopgarnityr Rund fläns med runda och fyrkantiga lock med olika märkning Svart primer</p>  <p>Betäckning i segjärn för AVK teleskopgarnityr Fyrkantfläns med runda och fyrkantiga lock med olika märkning Svart primer</p>	<table border="1"> <thead> <tr> <th>AVK nr.</th> <th>RSK nr.</th> <th>L mm</th> <th>Vikt</th> <th>St/pall</th> <th>Kod</th> </tr> </thead> <tbody> <tr> <td>04-008-75-06908</td> <td>7034102</td> <td>Ø 210 Ø RAM # PROPP "V"</td> <td>7</td> <td>54</td> <td>A</td> </tr> <tr> <td>04-008-25-05908</td> <td>7034103</td> <td>Ø 210 Ø RAM Ø PROPP "V"</td> <td>6,7</td> <td>54</td> <td>A</td> </tr> <tr> <td>04-008-75-05908</td> <td>7034110</td> <td>Ø 210 Ø RAM Ø PROPP "A"</td> <td>6,7</td> <td>54</td> <td>A</td> </tr> <tr> <td>04-008-79-05908</td> <td>7034115</td> <td>Ø 210 Ø RAM Ø PROPP "TA"</td> <td>6,7</td> <td>54</td> <td>C</td> </tr> <tr> <td>04-008-71-05908</td> <td>7034669</td> <td>Ø 210 Ø RAM Ø PROPP "AV"</td> <td>6,7</td> <td>54</td> <td>A</td> </tr> </tbody> </table> <table border="1"> <thead> <tr> <th>AVK nr.</th> <th>RSK nr.</th> <th>L mm</th> <th>Vikt</th> <th>St/pall</th> <th>Kod</th> </tr> </thead> <tbody> <tr> <td>04-008-75-11908</td> <td>7034104</td> <td># 210 # RAM # PROPP "V"</td> <td>6,7</td> <td>40</td> <td>A</td> </tr> <tr> <td>04-008-25-10908</td> <td>7034105</td> <td># 180 # RAM Ø PROPP "V"</td> <td>6,7</td> <td>48</td> <td>A</td> </tr> <tr> <td>04-008-78-11908</td> <td>7034111</td> <td># 210 # RAM # PROPP "A"</td> <td>6,7</td> <td>54</td> <td>B</td> </tr> <tr> <td>04-008-71-10908</td> <td>7034670</td> <td># 180 # RAM Ø PROPP "AV"</td> <td>6,7</td> <td>48</td> <td>C</td> </tr> </tbody> </table>	AVK nr.	RSK nr.	L mm	Vikt	St/pall	Kod	04-008-75-06908	7034102	Ø 210 Ø RAM # PROPP "V"	7	54	A	04-008-25-05908	7034103	Ø 210 Ø RAM Ø PROPP "V"	6,7	54	A	04-008-75-05908	7034110	Ø 210 Ø RAM Ø PROPP "A"	6,7	54	A	04-008-79-05908	7034115	Ø 210 Ø RAM Ø PROPP "TA"	6,7	54	C	04-008-71-05908	7034669	Ø 210 Ø RAM Ø PROPP "AV"	6,7	54	A	AVK nr.	RSK nr.	L mm	Vikt	St/pall	Kod	04-008-75-11908	7034104	# 210 # RAM # PROPP "V"	6,7	40	A	04-008-25-10908	7034105	# 180 # RAM Ø PROPP "V"	6,7	48	A	04-008-78-11908	7034111	# 210 # RAM # PROPP "A"	6,7	54	B	04-008-71-10908	7034670	# 180 # RAM Ø PROPP "AV"	6,7	48	C
AVK nr.	RSK nr.	L mm	Vikt	St/pall	Kod																																																														
04-008-75-06908	7034102	Ø 210 Ø RAM # PROPP "V"	7	54	A																																																														
04-008-25-05908	7034103	Ø 210 Ø RAM Ø PROPP "V"	6,7	54	A																																																														
04-008-75-05908	7034110	Ø 210 Ø RAM Ø PROPP "A"	6,7	54	A																																																														
04-008-79-05908	7034115	Ø 210 Ø RAM Ø PROPP "TA"	6,7	54	C																																																														
04-008-71-05908	7034669	Ø 210 Ø RAM Ø PROPP "AV"	6,7	54	A																																																														
AVK nr.	RSK nr.	L mm	Vikt	St/pall	Kod																																																														
04-008-75-11908	7034104	# 210 # RAM # PROPP "V"	6,7	40	A																																																														
04-008-25-10908	7034105	# 180 # RAM Ø PROPP "V"	6,7	48	A																																																														
04-008-78-11908	7034111	# 210 # RAM # PROPP "A"	6,7	54	B																																																														
04-008-71-10908	7034670	# 180 # RAM Ø PROPP "AV"	6,7	48	C																																																														
<p>Serie 04/008 Betäckning i segjärn för AVK teleskopgarnityr Rund fläns Fyrkantfläns Inskription "FK" FK = FjärrKyla</p> 	<table border="1"> <thead> <tr> <th>AVK nr.</th> <th>RSK nr.</th> <th>L mm</th> <th>Vikt</th> <th>St/pall</th> <th>Kod</th> </tr> </thead> <tbody> <tr> <td>04-008-21-05908</td> <td>7034106</td> <td>Ø 210 Ø RAM Ø PROPP "FK"</td> <td>6,7</td> <td>54</td> <td>A</td> </tr> <tr> <td>04-008-21-10908</td> <td>7034107</td> <td># 180 # RAM Ø PROPP "FK"</td> <td>6,7</td> <td>48</td> <td>B</td> </tr> </tbody> </table>	AVK nr.	RSK nr.	L mm	Vikt	St/pall	Kod	04-008-21-05908	7034106	Ø 210 Ø RAM Ø PROPP "FK"	6,7	54	A	04-008-21-10908	7034107	# 180 # RAM Ø PROPP "FK"	6,7	48	B																																																
AVK nr.	RSK nr.	L mm	Vikt	St/pall	Kod																																																														
04-008-21-05908	7034106	Ø 210 Ø RAM Ø PROPP "FK"	6,7	54	A																																																														
04-008-21-10908	7034107	# 180 # RAM Ø PROPP "FK"	6,7	48	B																																																														
<p>Serie 04/007-002 Betäckning i komposit för AVK teleskopiskt garnityr Rund fläns Svart primer "V"-inskriftion</p>  <p>Betäckning i komposit för AVK teleskopiskt garnityr Fyrkantfläns Svart primer "V"-inskriftion</p>	<table border="1"> <thead> <tr> <th>AVK nr.</th> <th>RSK nr.</th> <th>L mm</th> <th>Vikt</th> <th>St/pall</th> <th>Kod</th> </tr> </thead> <tbody> <tr> <td>04-007-75-06908</td> <td>7037636</td> <td>Ø 210 Ø RAM # PROPP "V"</td> <td>4,3</td> <td>48</td> <td>B</td> </tr> <tr> <td>04-007-25-05908</td> <td>7037642</td> <td>Ø 210 Ø RAM Ø PROPP "V"</td> <td>4,3</td> <td>48</td> <td>B</td> </tr> <tr> <td>04-007-75-11908</td> <td>7037637</td> <td># 210 # RAM # PROPP "V"</td> <td>4,3</td> <td>48</td> <td>B</td> </tr> <tr> <td>04-007-25-10908</td> <td>7037643</td> <td># 180 # RAM Ø PROPP "V"</td> <td>4,3</td> <td>48</td> <td>B</td> </tr> </tbody> </table>	AVK nr.	RSK nr.	L mm	Vikt	St/pall	Kod	04-007-75-06908	7037636	Ø 210 Ø RAM # PROPP "V"	4,3	48	B	04-007-25-05908	7037642	Ø 210 Ø RAM Ø PROPP "V"	4,3	48	B	04-007-75-11908	7037637	# 210 # RAM # PROPP "V"	4,3	48	B	04-007-25-10908	7037643	# 180 # RAM Ø PROPP "V"	4,3	48	B																																				
AVK nr.	RSK nr.	L mm	Vikt	St/pall	Kod																																																														
04-007-75-06908	7037636	Ø 210 Ø RAM # PROPP "V"	4,3	48	B																																																														
04-007-25-05908	7037642	Ø 210 Ø RAM Ø PROPP "V"	4,3	48	B																																																														
04-007-75-11908	7037637	# 210 # RAM # PROPP "V"	4,3	48	B																																																														
04-007-25-10908	7037643	# 180 # RAM Ø PROPP "V"	4,3	48	B																																																														
<p>Serie 04/088-001 Betäckning i segjärn för AVK teleskopiskt garnityr Svart primer, Rund propp med "V"-inskriftion Fyrkantpropp med "A"-inskriftion</p> 	<table border="1"> <thead> <tr> <th>AVK nr.</th> <th>RSK nr.</th> <th>Vikt</th> <th>St/pall</th> <th>Kod</th> </tr> </thead> <tbody> <tr> <td>04-088-40-08</td> <td>7034108</td> <td>Ø PROPP "V" OCH # "A"</td> <td>13,7</td> <td>28</td> <td>A</td> </tr> </tbody> </table>	AVK nr.	RSK nr.	Vikt	St/pall	Kod	04-088-40-08	7034108	Ø PROPP "V" OCH # "A"	13,7	28	A																																																							
AVK nr.	RSK nr.	Vikt	St/pall	Kod																																																															
04-088-40-08	7034108	Ø PROPP "V" OCH # "A"	13,7	28	A																																																														
<p>Serie 04 Propp</p> <p>Olika sorters proppar med olika märkning Tillverkade av segjärn</p> 	<table border="1"> <thead> <tr> <th>AVK nr.</th> <th>RSK nr.</th> <th>Vikt</th> <th>St/pall</th> <th>Kod</th> </tr> </thead> <tbody> <tr> <td>04-007-75-08</td> <td>7037654</td> <td># PROPP "V"</td> <td>4,2</td> <td>54</td> <td>A</td> </tr> <tr> <td>04-007-78-00908</td> <td>7034112</td> <td># PROPP "A"</td> <td>4,2</td> <td>54</td> <td>A</td> </tr> <tr> <td>04-007-77-08</td> <td>7034113</td> <td>Ø PROPP "FK"</td> <td>1,66</td> <td>54</td> <td>A</td> </tr> <tr> <td>04-007-25-08</td> <td>7037644</td> <td>Ø PROPP "V"</td> <td>4,2</td> <td>54</td> <td>A</td> </tr> <tr> <td>04-007-27-00908</td> <td>7034114</td> <td>Ø PROPP "A"</td> <td>4,2</td> <td>54</td> <td>A</td> </tr> <tr> <td>04-007-79-00908</td> <td>7034116</td> <td>Ø PROPP "TA"</td> <td>4,2</td> <td>54</td> <td>A</td> </tr> </tbody> </table>	AVK nr.	RSK nr.	Vikt	St/pall	Kod	04-007-75-08	7037654	# PROPP "V"	4,2	54	A	04-007-78-00908	7034112	# PROPP "A"	4,2	54	A	04-007-77-08	7034113	Ø PROPP "FK"	1,66	54	A	04-007-25-08	7037644	Ø PROPP "V"	4,2	54	A	04-007-27-00908	7034114	Ø PROPP "A"	4,2	54	A	04-007-79-00908	7034116	Ø PROPP "TA"	4,2	54	A																									
AVK nr.	RSK nr.	Vikt	St/pall	Kod																																																															
04-007-75-08	7037654	# PROPP "V"	4,2	54	A																																																														
04-007-78-00908	7034112	# PROPP "A"	4,2	54	A																																																														
04-007-77-08	7034113	Ø PROPP "FK"	1,66	54	A																																																														
04-007-25-08	7037644	Ø PROPP "V"	4,2	54	A																																																														
04-007-27-00908	7034114	Ø PROPP "A"	4,2	54	A																																																														
04-007-79-00908	7034116	Ø PROPP "TA"	4,2	54	A																																																														

Serie 04 Garnityrstöd för 2st garnityr		AVK nr. 970-4080-035-00191	RSK nr. 7037672	Vikt 0,1	Kod A				
Serie 04 Låsbygel till betäckning		AVK nr. 04-003-57	RSK nr. 7034117	Vikt 0,1	Kod B				
Demonteringsverktyg för PE-rör i insticks muffar Säljes 2st/påse		AVK nr. E2936 E2937 E2554 E2938 E2939	RSK nr. 2434589 2434590 2434591 2434592 2434593	PE-rör 25 32 40 50 63	Vikt 0,044 0,064 0,1 0,108 0,2	Kod A A A A A			
Plomberingsbricka med låsfjäder För servisgarnityr		AVK nr. 9705080035N42143 9705080035N42142	RSK nr. 2435231 2435232	PE-rör Bricka Fjäder	Vikt 0,008 0,012	Kod C C			
Serie 04-001 T-nyckel för garnityr DN 50-400		AVK nr. 04-050-2000 04-050-2100	RSK nr. 7037652 7037653	DN 32-63 75-400	Fyrkant F3 x F1 12 x 15 23 x 32	Vikt 2,2 2,7	St/pall 50 50	Kod A A	
Serie 04 Spindeladapter exkl saxpinnar		AVK nr. 04-040-46-000 04-063-46-000 04-080-46-000 04-225-06-00 04-315-06-00 04-400-06-00	RSK nr. 4256741 4256742 4256743 4219561 4219562 4219563	DN 40-50 65-80 100-150 200 250-300 350-400	Fyrkant 25 x 14 25 x 17 25 x 19 25 x 24 25 x 27 25 x 32	Vikt 0,8 0,8 0,8 0,8 0,8 0,8	Kod A A A A A A		
Serie 04 Saxpinnar		AVK nr. 04-400-08 04-161-08	Max hål Ø4 X 71 mm DIN94-A2 Ø4 X 50 mm DIN94-A2	L mm 82 63	Kod A A				
Serie 04 Lås-clip till servisgarnityr NYHET		AVK nr. 04-000-9400	Max hål Ø4 X 35 mm DIN94-A2		Kod A				
Serie 04 Nyckelhylsa enl SMS 1299 till AVK slussventil exkl saxpinne		AVK nr. 04-000-10-00 04-000-11-00 04-000-12-00 04-000-13-00 04-000-14-00 55-500-22-000 55-500-18-000	RSK nr. 4260315 4260316 4219564 4219565 4219566 4260334 4260335	DN 40-50 65-80 100-150 200 250-300 450-600 450-600	Förhöjer 8-10cm 8-10cm 8-10cm 9-11cm 11-13cm Ø30mm, 06 och 55/30 Ø40mm, 55/35	Vikt 1,1 1,1 1,2 1,8 1,8 3 3,5	Kod A A A A A C C		
Serie 08/A-004 Handträtt för ventiler Gråjärn DN 25-600 Epoxibelagt		AVK nr. 08-032-16 08-050-01-000 08-080-66-00000 08-100-66-00000 08-150-66-00000 08-200-66-00000 08-250-02-000 08-400-01-000 08-600-01-000	RSK nr. 4255329 4255320 4255321 4255322 4255323 4255324 4255325 4255326 4255427	DN 25-50 40-50 65-80 100 125-150 200 250-300 350-400 450-600	mm #13 #14 #17 #19 #19 #24 #27 #32 Ø30	Skruv M6x15 M8x20 M8x20 M8x20 M10x25 M10x25	Vikt 0,2 1,5 2 3,5 4,5 6 11 17 20	St/pall 330 288 165 110 77 60 22 14 10	Kod A A A A A A A B C



TELESKOPISK BRANDPOST INSTALLATION UNDER MARK

NYHET

Komplett brandpost förberedd att montera i brunn alternativt för direkt nedgrävning

Möjligt att justera längden med den dragfasta kopplingen

Underhållsfri konstruktion

Epoxymålning enligt DIN 30677-2 GSK

Mycket högt flöde **200m³/h**

NYHET
Serie 19/02

AVK Brandpost
Ventil, knäböj, koppling
Teleskopiskt rör
av segjärn PN 16
Målad enl GSK
EPDM gummi
Inklusive automatisk
dräneringsventil

Finns i 3 varianter

1. Komplett med trumma teleskop, betäckning, Trumma Ø425 och Supa Maxi™
2. Komplett med trumma teleskop och betäckning Trumma Ø425
3. Med fot

**Uttoppskoppling
beställs separat**

*** Med trumma, betäckning & Supa Maxi™**

AVK nr.	RSK nr.	DN	Längd mm	PN	Vikt	St/pall	Kod
971-019-035-7-1360	3995869	80	950-1390	16	62,7	1	A
971-019-035-7-2010	3995870	80	1270-2010	16	73,7	1	A
971-019-035-7-2620	3995871	80	1560-2590	16	82,7	1	B
971-019-035-7-3160	3995872	80	1960-3160	16	91,7	1	C
971-019-035-7-4960	3995873	80	2760-4960	16	100,7	1	C

*** Med trumma, teleskop & betäckning**

AVK nr.	RSK nr.	DN	Längd mm	PN	Vikt	St/pall	Kod
971-019-035-6-1360	3995864	80	950-1390	16	133,4	1	A
971-019-035-6-2010	3995865	80	1270-2010	16	144,4	1	A
971-019-035-6-2620	3995866	80	1560-2590	16	162,1	1	B
971-019-035-6-3160	3995867	80	1960-3160	16	171,1	1	C
971-019-035-6-4960	3995868	80	2760-4960	16	206,5	1	C

*** Med Fot**

AVK nr.	RSK nr.	DN	Längd mm	PN	Vikt	St/pall	Kod
971-019-035-5-1360	3995859	80	950-1390	16	62,7	1	A
971-019-035-5-2010	3995860	80	1270-2010	16	73,7	1	A
971-019-035-5-2620	3995861	80	1560-2590	16	82,7	1	B
971-019-035-5-3160	3995862	80	1960-3160	16	91,7	1	C
971-019-035-5-4960	3995863	80	2760-4960	16	100,7	1	C

AVK nr.	RSK nr.	TYP	Gängad	Kod
9645000003	4211014	TYP A	Gängad	A
9645000002	4211018	TYP B	Bajonettfattning	A
9645000001	4211026	TYP C	Billmann	A

Serie 633/10-004
Tillbehör till brandpost

AVK Supa Maxi™
Skräddarsydd för brandpost
Tolerans 104-133 mm
Universal dragfast fläns-koppling
För alla rörtyper såsom
gråjärn, segjärn,
rostfritt stål, PE,
PVC och AC



AVK nr.	RSK nr.	DN	T mm	PN	Vikt	St/pall	Kod
633-133-01-006	1142047	80	104-133	16	9	15	A
633-106-00-006	1141781	80	82-106	16	6,5	20	A

*** Stödhylsa**

* SDR 11	RSK nr.	DN	PE-rör	PN	Vikt	St/pall	Kod
05-090-84-000	1866696	80	90	16	0,7	208	A
05-110-84-000	1866697	100	110	16	0,8	150	A

* SDR 17	RSK nr.	DN	PE-rör	PN	Vikt	St/pall	Kod
05-090-83-000	1866684	80	90	16	0,7	250	A
05-110-83-000	1866685	100	110	16	0,8	300	A



BRANDPOST FÖR INSTALLATION UNDER MARK

Komplett brandpost med kort trumma
Epoxymålning enligt DIN 30677-2 GSK
Mycket högt flöde **136 m³/h**

Serie 35 komplett

Komplett brandpost:
1m Ständarrör, teleskop,
betäckning, flexdränering
och flänsad Supa
Maxi™



**Utloppskoppling
beställs separat**

AVK nr.	RSK nr.	DN	H (mm)	PE	PN	Vikt	Kod
971-035-035-61101	3995805	80	715	104-133	16	98,8	C
971-035-035-61103	3995806	80	890	104-133	16	102,5	C
971-035-035-61104	3995807	80	1140	104-133	16	108,2	A
971-035-035-61105	3995808	80	1390	104-133	16	110,4	A
971-035-035-61106	3995809	80	1640	104-133	16	118,9	C

Serie 35/85-006

Brandpost under mark
enl. DIN 3221-AD1-80
med monterat knärör
Utan utloppskoppling
DN80, PN 16
DIN - DVGW-godkänt
H 715 - 1640 mm
Flöde = 136m³/h



**Utloppskoppling
beställs separat**

AVK nr.	RSK nr.	DN	H (mm)	PN	Vikt	St/pall	Kod
35-080-85-15032	4203203	80	715	16	26		C
35-080-85-25032	4203204	80	890	16	30	8	C
35-080-85-35032	4203205	80	1140	16	36	8	A
35-080-85-45032	4203206	80	1390	16	38	8	A
35-080-85-55032	4203207	80	1640	16	46		C

AVK nr.	RSK nr.	TYP	Gängad	Kod
9645000003	4211014	TYP A	Gängad	A
9645000002	4211018	TYP B	Bajonettfattning	A
9645000001	4211026	TYP C	Billmann	A

Serie 633/10-004

Tillbehör till brandpost
AVK Supa Maxi™
Skräddarsydd för brandpost
Tolerans 104-133 mm
Universal dragfast fläns-kop-
pling
För alla rörtyper såsom
gråjärn, sejärn,
rostfritt stål, PE,
PVC och AC







AVK nr.	RSK nr.	DN	T mm	PN	Vikt	St/pall	Kod
63313301006	1142047	80	104-133	16	9	15	A
63310600006	1141781	80	82-106	16	6,5	20	A

* Stödhylsa







* SDR 11	RSK nr.	DN	PE-rör	PN	Vikt	St/pall	Kod
0509054000	1866696	80	90	16	0,7	208	A
0511074000	1866697	100	110	16	0,8	150	A

* SDR 17

* SDR 17	RSK nr.	DN	PE-rör	PN	Vikt	St/pall	Kod
0509053000	1866684	80	90	16	0,7	250	A
0511073000	1866685	100	110	16	0,8	300	A

<p>Serie 35 Brandpost-förhöjningsatts Spindelförlängare, utloppsförlängare, oring och bultar ingår.</p> 	<table border="1"> <thead> <tr> <th>AVK nr.</th> <th>RSK nr.</th> <th>L mm</th> <th>Kod</th> </tr> </thead> <tbody> <tr> <td>971-035-035-61100</td> <td>3995854</td> <td>100</td> <td>B</td> </tr> <tr> <td>971-035-035-61150</td> <td>3995855</td> <td>150</td> <td>B</td> </tr> <tr> <td>971-035-035-61200</td> <td>3995856</td> <td>200</td> <td>B</td> </tr> <tr> <td>971-035-035-61300</td> <td>3995857</td> <td>300</td> <td>B</td> </tr> </tbody> </table>	AVK nr.	RSK nr.	L mm	Kod	971-035-035-61100	3995854	100	B	971-035-035-61150	3995855	150	B	971-035-035-61200	3995856	200	B	971-035-035-61300	3995857	300	B								
AVK nr.	RSK nr.	L mm	Kod																										
971-035-035-61100	3995854	100	B																										
971-035-035-61150	3995855	150	B																										
971-035-035-61200	3995856	200	B																										
971-035-035-61300	3995857	300	B																										
<p>Utloppskopplingar passar till serie 19 och 35 Bultar och O-ring till utloppskoppling följer med Brandposten.</p> 	<table border="1"> <thead> <tr> <th>AVK nr.</th> <th>RSK nr.</th> <th></th> <th>Kod</th> </tr> </thead> <tbody> <tr> <td>9645000003 140134</td> <td>4211014</td> <td>Typ A Gångad Skyddslock till Typ A</td> <td>A A</td> </tr> <tr> <td>9645000002 140135</td> <td>4211018</td> <td>Typ B Bajonettfattning Skyddslock till Typ B</td> <td>A A</td> </tr> <tr> <td>9645000001 139722</td> <td>4211026</td> <td>Typ C Billmann Skyddslock till Typ C</td> <td>A A</td> </tr> </tbody> </table>	AVK nr.	RSK nr.		Kod	9645000003 140134	4211014	Typ A Gångad Skyddslock till Typ A	A A	9645000002 140135	4211018	Typ B Bajonettfattning Skyddslock till Typ B	A A	9645000001 139722	4211026	Typ C Billmann Skyddslock till Typ C	A A												
AVK nr.	RSK nr.		Kod																										
9645000003 140134	4211014	Typ A Gångad Skyddslock till Typ A	A A																										
9645000002 140135	4211018	Typ B Bajonettfattning Skyddslock till Typ B	A A																										
9645000001 139722	4211026	Typ C Billmann Skyddslock till Typ C	A A																										
<p>Serie 80/60 Flexdränering för brandposter med självvlänsande dränering</p> 	<table border="1"> <thead> <tr> <th>AVK nr.</th> <th>RSK nr.</th> <th>Vikt</th> <th>St/pall</th> <th>Kod</th> </tr> </thead> <tbody> <tr> <td>80-60-00001</td> <td>4203159</td> <td>0,8</td> <td>160</td> <td>A</td> </tr> </tbody> </table>	AVK nr.	RSK nr.	Vikt	St/pall	Kod	80-60-00001	4203159	0,8	160	A																		
AVK nr.	RSK nr.	Vikt	St/pall	Kod																									
80-60-00001	4203159	0,8	160	A																									
<p>Serie 84/40 Brandpost ovan mark Självttömmande Avstängning med kula inkl knärör Monterad med brytbleck Förhindrar att brandpost går sönder vid påkörning Model P5 "Nostalg" DN 80 Flöde = 170m³/h Finns presalkopplingar 32/63 lock</p> 	<table border="1"> <thead> <tr> <th>AVK nr.</th> <th>RSK nr.</th> <th>DN</th> <th>Koppling på sidorna</th> <th>Kod</th> </tr> </thead> <tbody> <tr> <td>84-080-55-331011</td> <td>4203224</td> <td>80</td> <td>2,5" Röd epoxy utv. inv. emalj</td> <td>B</td> </tr> <tr> <td>84-080-55-331051</td> <td>4203226</td> <td>80</td> <td>2,5" Blå epoxi utv. inv. emalj</td> <td>C</td> </tr> </tbody> </table> <p>* Rörtäckning som kan levereras 760 mm och 1260 mm * Presalkopplingar som finns * KOPPLINGSDEL 63/UTV.GGA 2,5 * LOCK-63MM KEDJA * ÖVERGÅNGSKOPPL. 63x32 * LOCK-32MM KEDJA</p> <table border="1"> <thead> <tr> <th>AVK nr.</th> <th>RSK nr.</th> <th>Kod</th> </tr> </thead> <tbody> <tr> <td>84-000-80</td> <td>4203227</td> <td>B</td> </tr> </tbody> </table> <p>* Nostalg brandpostnyckel</p>	AVK nr.	RSK nr.	DN	Koppling på sidorna	Kod	84-080-55-331011	4203224	80	2,5" Röd epoxy utv. inv. emalj	B	84-080-55-331051	4203226	80	2,5" Blå epoxi utv. inv. emalj	C	AVK nr.	RSK nr.	Kod	84-000-80	4203227	B							
AVK nr.	RSK nr.	DN	Koppling på sidorna	Kod																									
84-080-55-331011	4203224	80	2,5" Röd epoxy utv. inv. emalj	B																									
84-080-55-331051	4203226	80	2,5" Blå epoxi utv. inv. emalj	C																									
AVK nr.	RSK nr.	Kod																											
84-000-80	4203227	B																											
<p>Serie 78/7510-001 Dricksfontän tillverkad av segjärn Epoxibelagd PN10 DN40 Alternativ finns med inkoppling brandslang (Serie 78/7511-001)</p> 	<table border="1"> <thead> <tr> <th>AVK nr.</th> <th>RSK nr.</th> <th>DN</th> <th>H (mm)</th> <th>PN</th> <th>Vikt</th> <th>Kod</th> </tr> </thead> <tbody> <tr> <td>78-040-7510-100</td> <td>4203242</td> <td>40</td> <td>780 (1780)</td> <td>10</td> <td>100</td> <td>B</td> </tr> <tr> <td>* Med utloppskoppling</td> <td></td> <td></td> <td></td> <td></td> <td></td> <td></td> </tr> <tr> <td>78-040-7511-100</td> <td>4203243</td> <td>40</td> <td>780 (1780)</td> <td>10</td> <td>109</td> <td>C</td> </tr> </tbody> </table>	AVK nr.	RSK nr.	DN	H (mm)	PN	Vikt	Kod	78-040-7510-100	4203242	40	780 (1780)	10	100	B	* Med utloppskoppling							78-040-7511-100	4203243	40	780 (1780)	10	109	C
AVK nr.	RSK nr.	DN	H (mm)	PN	Vikt	Kod																							
78-040-7510-100	4203242	40	780 (1780)	10	100	B																							
* Med utloppskoppling																													
78-040-7511-100	4203243	40	780 (1780)	10	109	C																							

<p>Serie 712/3550-002 Reduktionsfläns</p> 	<table border="1"> <thead> <tr> <th>AVK nr.</th> <th>RSK nr.</th> <th>DN</th> <th>PN</th> <th>Vikt</th> <th>Kod</th> </tr> </thead> <tbody> <tr> <td>712-0101-35-501061</td> <td>4203228</td> <td>100-80/8</td> <td>10/16</td> <td>8</td> <td>C</td> </tr> </tbody> </table>	AVK nr.	RSK nr.	DN	PN	Vikt	Kod	712-0101-35-501061	4203228	100-80/8	10/16	8	C									
AVK nr.	RSK nr.	DN	PN	Vikt	Kod																	
712-0101-35-501061	4203228	100-80/8	10/16	8	C																	
<p>Serie 712/70 Rörbøj med fläns och fot DN 80 DN 100 GGG-50</p> 	<table border="1"> <thead> <tr> <th>AVK nr.</th> <th>RSK nr.</th> <th>DN</th> <th>H</th> <th>PN</th> <th>Vikt</th> <th>Kod</th> </tr> </thead> <tbody> <tr> <td>712-0080-70-101</td> <td>4203166</td> <td>80</td> <td>165</td> <td>16</td> <td>12</td> <td>C</td> </tr> <tr> <td>712-0100-70-101</td> <td>4203225</td> <td>100</td> <td>180</td> <td>16</td> <td>15</td> <td>C</td> </tr> </tbody> </table>	AVK nr.	RSK nr.	DN	H	PN	Vikt	Kod	712-0080-70-101	4203166	80	165	16	12	C	712-0100-70-101	4203225	100	180	16	15	C
AVK nr.	RSK nr.	DN	H	PN	Vikt	Kod																
712-0080-70-101	4203166	80	165	16	12	C																
712-0100-70-101	4203225	100	180	16	15	C																
<p>FURNES Betäckning för brandpost under jord Hus i Segjärn</p> 	<table border="1"> <thead> <tr> <th>AVK nr.</th> <th>RSK nr.</th> <th>Ø mm</th> <th>Vikt</th> <th>St/pall</th> <th>Kod</th> </tr> </thead> <tbody> <tr> <td>97050800357032532</td> <td>7025477</td> <td>425</td> <td>41</td> <td>24</td> <td>A</td> </tr> </tbody> </table>	AVK nr.	RSK nr.	Ø mm	Vikt	St/pall	Kod	97050800357032532	7025477	425	41	24	A									
AVK nr.	RSK nr.	Ø mm	Vikt	St/pall	Kod																	
97050800357032532	7025477	425	41	24	A																	
<p>Ståndarrör Olika längder</p> 	<table border="1"> <thead> <tr> <th>AVK nr.</th> <th>RSK nr.</th> <th>L mm</th> <th>Ø mm</th> <th>Vikt</th> <th>St/pall</th> <th>Kod</th> </tr> </thead> <tbody> <tr> <td>97050800350513510</td> <td>2435208</td> <td>1000</td> <td>425</td> <td>9</td> <td>4</td> <td>A</td> </tr> <tr> <td>97050800350513520</td> <td>2358103</td> <td>2000</td> <td>425</td> <td>17,56</td> <td>4</td> <td>A</td> </tr> </tbody> </table>	AVK nr.	RSK nr.	L mm	Ø mm	Vikt	St/pall	Kod	97050800350513510	2435208	1000	425	9	4	A	97050800350513520	2358103	2000	425	17,56	4	A
AVK nr.	RSK nr.	L mm	Ø mm	Vikt	St/pall	Kod																
97050800350513510	2435208	1000	425	9	4	A																
97050800350513520	2358103	2000	425	17,56	4	A																
<p>Teleskop till ståndarrör Tätningring ingår</p> 	<table border="1"> <thead> <tr> <th>AVK nr.</th> <th>RSK nr.</th> <th>L mm</th> <th>Ø mm</th> <th>Vikt</th> <th>St/pall</th> <th>Kod</th> </tr> </thead> <tbody> <tr> <td>97050800350547285</td> <td>2358212</td> <td>750</td> <td>425</td> <td>12</td> <td>8</td> <td>A</td> </tr> </tbody> </table>	AVK nr.	RSK nr.	L mm	Ø mm	Vikt	St/pall	Kod	97050800350547285	2358212	750	425	12	8	A							
AVK nr.	RSK nr.	L mm	Ø mm	Vikt	St/pall	Kod																
97050800350547285	2358212	750	425	12	8	A																

<p>Serie 701/10-001 Automatisk avluftsventil 0,2 - 16 bar Förstärkt nylon PN 16 DN 20-25</p>  <p>Alternativ: med mässingsanslutning</p>	<table border="1"> <thead> <tr> <th>AVK nr.</th> <th>RSK nr.</th> <th>DN</th> <th>BSP</th> <th>PN</th> <th>Vikt</th> <th>St/pall</th> <th>Kod</th> </tr> </thead> <tbody> <tr> <td>701-025-10-99003</td> <td>4287800</td> <td>20</td> <td>¾"</td> <td>16</td> <td>0,3</td> <td>10</td> <td>A</td> </tr> <tr> <td>701-025-11-99003 *</td> <td>4287801</td> <td>20</td> <td>¾"</td> <td>16</td> <td>0,7</td> <td>10</td> <td>A</td> </tr> <tr> <td>701-032-10-99003</td> <td>4287659</td> <td>25</td> <td>1"</td> <td>16</td> <td>0,3</td> <td>10</td> <td>A</td> </tr> <tr> <td>701-032-11-99003 *</td> <td>4287640</td> <td>25</td> <td>1"</td> <td>16</td> <td>0,65</td> <td>10</td> <td>B</td> </tr> </tbody> </table> <p>* mässingunderdel</p>	AVK nr.	RSK nr.	DN	BSP	PN	Vikt	St/pall	Kod	701-025-10-99003	4287800	20	¾"	16	0,3	10	A	701-025-11-99003 *	4287801	20	¾"	16	0,7	10	A	701-032-10-99003	4287659	25	1"	16	0,3	10	A	701-032-11-99003 *	4287640	25	1"	16	0,65	10	B								
AVK nr.	RSK nr.	DN	BSP	PN	Vikt	St/pall	Kod																																										
701-025-10-99003	4287800	20	¾"	16	0,3	10	A																																										
701-025-11-99003 *	4287801	20	¾"	16	0,7	10	A																																										
701-032-10-99003	4287659	25	1"	16	0,3	10	A																																										
701-032-11-99003 *	4287640	25	1"	16	0,65	10	B																																										
<p>Serie 701/30-010 Dubbelverkande avluftsventil Inloppsfläns 0,2 - 16 bar Epoxibeläggning PN 16 DN 50-150 (ej DN 100)</p> 	<table border="1"> <thead> <tr> <th>AVK nr.</th> <th>RSK nr.</th> <th>DN</th> <th>BSP</th> <th>PN</th> <th>Vikt</th> <th>St/pall</th> <th>Kod</th> </tr> </thead> <tbody> <tr> <td>701-050-30-11003</td> <td>4287757</td> <td>50</td> <td></td> <td>16</td> <td>6,1</td> <td>30</td> <td>B</td> </tr> <tr> <td>701-051-30-91003</td> <td>4287758</td> <td>50</td> <td>2"</td> <td>16</td> <td>4</td> <td>30</td> <td>C</td> </tr> <tr> <td>701-080-30-11003</td> <td>4287759</td> <td>80</td> <td></td> <td>16</td> <td>13</td> <td>20</td> <td>C</td> </tr> <tr> <td>701-081-30-91003</td> <td>4287816</td> <td>80</td> <td>3"</td> <td>16</td> <td>9,6</td> <td>20</td> <td>C</td> </tr> <tr> <td>701-150-30-11003</td> <td>4287761</td> <td>150</td> <td></td> <td>16</td> <td>43</td> <td>5</td> <td>C</td> </tr> </tbody> </table>	AVK nr.	RSK nr.	DN	BSP	PN	Vikt	St/pall	Kod	701-050-30-11003	4287757	50		16	6,1	30	B	701-051-30-91003	4287758	50	2"	16	4	30	C	701-080-30-11003	4287759	80		16	13	20	C	701-081-30-91003	4287816	80	3"	16	9,6	20	C	701-150-30-11003	4287761	150		16	43	5	C
AVK nr.	RSK nr.	DN	BSP	PN	Vikt	St/pall	Kod																																										
701-050-30-11003	4287757	50		16	6,1	30	B																																										
701-051-30-91003	4287758	50	2"	16	4	30	C																																										
701-080-30-11003	4287759	80		16	13	20	C																																										
701-081-30-91003	4287816	80	3"	16	9,6	20	C																																										
701-150-30-11003	4287761	150		16	43	5	C																																										
<p>Serie 701/30-020 Dubbelverkande avluftsventil Inloppsfläns 0,2 - 16 bar Epoxibeläggning PN 16 DN 100 - 300 (ej DN 150)</p> 	<table border="1"> <thead> <tr> <th>AVK nr.</th> <th>RSK nr.</th> <th>DN</th> <th>PN</th> <th>Vikt</th> <th>St/pall</th> <th>Kod</th> </tr> </thead> <tbody> <tr> <td>701-100-30-11003</td> <td>4287760</td> <td>100</td> <td>10/16</td> <td>27</td> <td>10</td> <td>C</td> </tr> <tr> <td>701-200-30-01003</td> <td>4287817</td> <td>200</td> <td>10</td> <td>116</td> <td>2</td> <td>C</td> </tr> <tr> <td>701-200-30-11003</td> <td>4287818</td> <td>200</td> <td>16</td> <td>116</td> <td>2</td> <td>C</td> </tr> </tbody> </table>	AVK nr.	RSK nr.	DN	PN	Vikt	St/pall	Kod	701-100-30-11003	4287760	100	10/16	27	10	C	701-200-30-01003	4287817	200	10	116	2	C	701-200-30-11003	4287818	200	16	116	2	C																				
AVK nr.	RSK nr.	DN	PN	Vikt	St/pall	Kod																																											
701-100-30-11003	4287760	100	10/16	27	10	C																																											
701-200-30-01003	4287817	200	10	116	2	C																																											
701-200-30-11003	4287818	200	16	116	2	C																																											
<p>Serie 701/40-010 Kombinerad avluftsventil BSP-Gänga 0,2 16 bar Förstärkt Nylon DN20 - DN 50</p> 	<table border="1"> <thead> <tr> <th>AVK nr.</th> <th>RSK nr.</th> <th>DN</th> <th>BSP</th> <th>PN</th> <th>Vikt</th> <th>St/pall</th> <th>Kod</th> </tr> </thead> <tbody> <tr> <td>701-020-40-99003</td> <td>4287802</td> <td>20</td> <td>¾"</td> <td>16</td> <td>0,3</td> <td>50</td> <td>B</td> </tr> <tr> <td>701-025-40-99003</td> <td>4287676</td> <td>25</td> <td>1"</td> <td>16</td> <td>0,3</td> <td>70</td> <td>A</td> </tr> <tr> <td>701-050-40-99003</td> <td>4287660</td> <td>50</td> <td>2"</td> <td>16</td> <td>1</td> <td>60</td> <td>A</td> </tr> <tr> <td>701-050-41-99003</td> <td>4287641</td> <td>50</td> <td>2"</td> <td>16</td> <td>2</td> <td>30</td> <td>B</td> </tr> </tbody> </table> <p>* mässingunderdel</p>	AVK nr.	RSK nr.	DN	BSP	PN	Vikt	St/pall	Kod	701-020-40-99003	4287802	20	¾"	16	0,3	50	B	701-025-40-99003	4287676	25	1"	16	0,3	70	A	701-050-40-99003	4287660	50	2"	16	1	60	A	701-050-41-99003	4287641	50	2"	16	2	30	B								
AVK nr.	RSK nr.	DN	BSP	PN	Vikt	St/pall	Kod																																										
701-020-40-99003	4287802	20	¾"	16	0,3	50	B																																										
701-025-40-99003	4287676	25	1"	16	0,3	70	A																																										
701-050-40-99003	4287660	50	2"	16	1	60	A																																										
701-050-41-99003	4287641	50	2"	16	2	30	B																																										
<p>Serie 701/50-003 Kombinerad avluftsventil Inloppsfläns Gråjärn Epoxibeläggning in- och utvändigt PN 16 DN 50-150</p> 	<table border="1"> <thead> <tr> <th>AVK nr.</th> <th>RSK nr.</th> <th>DN</th> <th>PN</th> <th>Vikt</th> <th>St/pall</th> <th>Kod</th> </tr> </thead> <tbody> <tr> <td>701-050-50-11003</td> <td>4287643</td> <td>50</td> <td>16</td> <td>6,4</td> <td>10</td> <td>B</td> </tr> <tr> <td>701-051-50-91003</td> <td>4287662</td> <td>50</td> <td>16</td> <td>4,3</td> <td>10</td> <td>C</td> </tr> <tr> <td>701-080-50-11003</td> <td>4287644</td> <td>80</td> <td>16</td> <td>13</td> <td>10</td> <td>C</td> </tr> <tr> <td>701-081-50-91003</td> <td>4287811</td> <td>80</td> <td>16</td> <td>10</td> <td>10</td> <td>C</td> </tr> </tbody> </table> <p>* Inlopp 2" utvändigt BSP gänga ** Inlopp 3" utvändigt BSP gänga</p>	AVK nr.	RSK nr.	DN	PN	Vikt	St/pall	Kod	701-050-50-11003	4287643	50	16	6,4	10	B	701-051-50-91003	4287662	50	16	4,3	10	C	701-080-50-11003	4287644	80	16	13	10	C	701-081-50-91003	4287811	80	16	10	10	C													
AVK nr.	RSK nr.	DN	PN	Vikt	St/pall	Kod																																											
701-050-50-11003	4287643	50	16	6,4	10	B																																											
701-051-50-91003	4287662	50	16	4,3	10	C																																											
701-080-50-11003	4287644	80	16	13	10	C																																											
701-081-50-91003	4287811	80	16	10	10	C																																											
<p>Serie 701/50-020 Kombinerad avluftsventil Inloppsfläns Gråjärn Epoxibeläggning in- och utvändigt PN 16 DN 100-200</p> 	<table border="1"> <thead> <tr> <th>AVK nr.</th> <th>RSK nr.</th> <th>DN</th> <th>PN</th> <th>Vikt</th> <th>St/pall</th> <th>Kod</th> </tr> </thead> <tbody> <tr> <td>701-100-50-11003</td> <td>4287668</td> <td>100</td> <td>16</td> <td>26</td> <td>6</td> <td>C</td> </tr> <tr> <td>701-150-50-11003</td> <td>4287669</td> <td>150</td> <td>16</td> <td>43</td> <td>5</td> <td>C</td> </tr> <tr> <td>701-200-50-01003</td> <td>4287762</td> <td>200</td> <td>10</td> <td>117</td> <td>2</td> <td>C</td> </tr> <tr> <td>701-200-50-11003</td> <td>4287670</td> <td>200</td> <td>16</td> <td>117</td> <td>2</td> <td>C</td> </tr> </tbody> </table>	AVK nr.	RSK nr.	DN	PN	Vikt	St/pall	Kod	701-100-50-11003	4287668	100	16	26	6	C	701-150-50-11003	4287669	150	16	43	5	C	701-200-50-01003	4287762	200	10	117	2	C	701-200-50-11003	4287670	200	16	117	2	C													
AVK nr.	RSK nr.	DN	PN	Vikt	St/pall	Kod																																											
701-100-50-11003	4287668	100	16	26	6	C																																											
701-150-50-11003	4287669	150	16	43	5	C																																											
701-200-50-01003	4287762	200	10	117	2	C																																											
701-200-50-11003	4287670	200	16	117	2	C																																											
<p>Serie 701/11 Isoleringskydd för Barak D-040</p> 	<table border="1"> <thead> <tr> <th>AVK nr.</th> <th>RSK nr.</th> <th>BSP</th> <th>Kod</th> </tr> </thead> <tbody> <tr> <td>701-032-1101</td> <td>3481772</td> <td>1"</td> <td>C</td> </tr> <tr> <td>701-050-1101</td> <td>3481773</td> <td>2"</td> <td>C</td> </tr> </tbody> </table>	AVK nr.	RSK nr.	BSP	Kod	701-032-1101	3481772	1"	C	701-050-1101	3481773	2"	C																																				
AVK nr.	RSK nr.	BSP	Kod																																														
701-032-1101	3481772	1"	C																																														
701-050-1101	3481773	2"	C																																														

Serie 701/84-002

Underjordsavluffare
500–2440 mm längd
Segjärn
0,2 - 16 bar
Gångad anslutning:
DN50
Flänsanslutning:
DN 50, 80, 100
PN 16

Alternativ:
PN 0,1-10 bar



AVK nr. (Gångad)	RSK nr.	DN	Höjd mm	BSP	PN	Vikt	Kod
701-050-84-01002	4287768	50	500	2"	0,2-16	7	C
701-050-84-02002	4287769	50	755	2"	0,2-16	8,5	A
701-050-84-03002	4287770	50	1055	2"	0,2-16	9,8	A
701-050-84-04002	4287771	50	1305	2"	0,2-16	11	C
701-050-84-05002	4287772	50	1555	2"	0,2-16	12	C
701-050-84-06002	4287773	50	1830	2"	0,2-16	14	C
701-050-84-07002	4287774	50	2135	2"	0,2-16	15	C
701-050-84-08002	4287775	50	2440	2"	0,2-16	16	C

AVK nr. (Flänsad)	RSK nr.	DN	Höjd mm	PN	Vikt	Kod
701-050-84-11002	4287776	50	500	0,2-16	7	C
701-050-84-12002	4287777	50	755	0,2-16	8,5	A
701-050-84-13002	4287778	50	1055	0,2-16	9,8	A
701-050-84-14002	4287779	50	1305	0,2-16	11	C
701-050-84-15002	4287780	50	1555	0,2-16	12	C
701-050-84-16002	4287781	50	1830	0,2-16	14	C
701-050-84-17002	4287782	50	2135	0,2-16	15	C
701-050-84-18002	4287783	50	2440	0,2-16	16	C

AVK nr. (Flänsad)	RSK nr.	DN	Höjd mm	PN	Vikt	Kod
701-080-84-21002	4287784	80	500	0,2-16	7	C
701-080-84-22002	4287785	80	755	0,2-16	8,5	A
701-080-84-23002	4287786	80	1055	0,2-16	9,8	A
701-080-84-24002	4287787	80	1305	0,2-16	11	C
701-080-84-25002	4287788	80	1555	0,2-16	12	C
701-080-84-26002	4287789	80	1830	0,2-16	14	C
701-080-84-27002	4287790	80	2135	0,2-16	15	C
701-080-84-28002	4287791	80	2440	0,2-16	16	C

AVK nr. (Flänsad)	RSK nr.	DN	Höjd mm	PN	Vikt	Kod
701-100-84-31002	4287792	100	500	0,2-16	7	C
701-100-84-32002	4287793	100	755	0,2-16	8,5	A
701-100-84-33002	4287794	100	1055	0,2-16	9,8	A
701-100-84-34002	4287795	100	1305	0,2-16	11	C
701-100-84-35002	4287796	100	1555	0,2-16	12	C
701-100-84-36002	4287797	100	1830	0,2-16	14	C
701-100-84-37002	4287798	100	2135	0,2-16	15	C
701-100-84-38002	4287799	100	2440	0,2-16	16	C

Serie 701/48-010

Kombinerad
avlufningsventil
För högt flöde
Förstärkt nylon
Med invändig gänga
PN 16
DN 50



AVK nr.	RSK nr.	DN	BSP	PN	Vikt	Kod
701-051-48-990037	4294974	50	2"	16	0,45	B

Serie 701/48-020

Kombinerad
avlufningsventil
För högt flöde
Segjärn
Med fläns
PN 16
DN 50-150



AVK nr.	RSK nr.	DN	PN	Vikt	Kod
701-050-48-110034	4294975	50	16	3,7	B
701-080-48-110034	4294976	80	16	8,6	B
701-100-48-110034	4294977	100	16	18,2	B
701-150-48-110034	4294978	150	16	30,4	B



KLAFFBACK- VENTILER MED FJÄDERPAKET

Driftsäker backventil som är lätt att underhålla
Backspolningsmöjlighet
Med fjäderpaketet så dämpas tryckslag i ledningar

Serie 41/60-003

Backventil med klaff
Mjuktätande
Med fri axelände på
höger sida
Segjärn
Epoxibeläggning
in- och utvändigt
PN 10/16
DN 50-300



Tillbehör:

- 1 Arm och vikt
- 2 Fjädersats

AVK nr.	RSK nr.	DN	Längd	PN	Vikt	St/pall	Kod
41-050-60-018	4425510	50	200	10/16	13	18	A
41-065-60-018	4291356	65	230	10/16	16	15	A
41-080-60-018	4291357	80	260	10/16	20	16	A
41-100-60-018	4291358	100	300	10/16	26	12	A
41-125-60-018	4291359	125	350	10/16	36	8	B
41-150-60-018	4291360	150	400	10/16	51	6	A
41-200-60-008	4291361	200	500	10	83	4	A
41-200-60-018	4291362	200	500	16	83	4	C
41-250-60-008	4291363	250	600	10	183	2	A
41-250-60-018	4291364	250	600	16	183	2	C
41-300-60-008	4291365	300	700	10	231	2	B
41-300-60-018	4291366	300	700	16	231	2	C

Serie 41/D-001

Arm och vikt för AVK
backventil med klaff
Serie 41/60
Epoxibeläggning
DN 50-300



AVK nr.	RSK nr.	DN	Vikt	St/pall	Kod
41-080-23-000	4291333	50-80	2,5	120	A
41-100-23-000	4291334	100	3,5	100	A
41-150-23-000	4291335	125-150	5,2	88	A
41-200-23-000	4291336	200	13	40	A
41-300-23-000	4291337	250-300	13	88	A

Serie 41/32-001

Fjädersats för AVK
backventil med klaff
Serie 41/60
Epoxibeläggning
DN 50-300

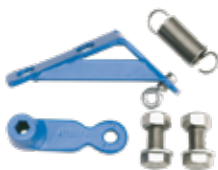

AVK nr.	RSK nr.	DN	Vikt	St/pall	Kod
41-050-32-000	4291338	50	2	88	B
41-065-32-000	4291339	65	2	50	A
41-080-32-000	4291340	80	3	25	A
41-100-32-000	4291341	100	3,4	88	A
41-125-32-000	4291342	125	3,4	88	B
41-150-32-000	4291343	150	3,4	20	A
41-200-32-000	4291344	200	8	88	A
41-300-32-000	4291346	300	10	6	A

Serie 41/I-002

Skydd för arm och vikt
för AVK
backventil med klaff
Serie 41/60



AVK nr.	RSK nr.	DN	Vikt	St/pall	Kod
41-080-50-009	4291296	50-80	2	20	C
41-100-50-009	4291297	100	2,2	20	C
41-150-50-009	4291298	125-150	5	20	C
41-200-50-009	4291299	200	7	20	C
41-300-50-009	4291300	250-300	10	15	C

SERVISVENTILER MED NBR-GUMMI

Ventilerna har NBR-gummi för att fungera i avloppsvatten
Elektrostatiskt applicerad epoxi-beläggning enligt DIN
30677-2 och GSK riktlinjer
Ventilspindel av syrafast stål.



NYHET

Serie 16/05-015

Servisventil med
dragfasta skruvkopplingar
för PE-rör

NBR-Gummi

Mässing
PN 16
DN 25-50
AVK-topp



Uppgraderades under 2021 med spindel av DUPLEX 1.4362

AVK nr.	RSK nr.	DN	PE-rör	PN	Vikt	St/pall	Kod
16-032-05-0030099	4328519	25	32	16	2	64	C
16-040-05-0030099	4328520	32	40	16	2,3	64	A
16-050-05-003	4328521	40	50	16	3	41	A
16-063-05-003	4328522	50	63	16	3,5	30	A

NYHET

Serie 16/25-015

Servisventil
med dragfasta
PRK-kopplingar
för PE-rör

NBR-Gummi

Mässing
PN 16
DN 25-50
AVK-topp



Uppgraderades under 2021 med spindel av DUPLEX 1.4362

AVK nr.	RSK nr.	DN	PE-rör	PN	Vikt	St/pall	Kod
16-032-25-0030099	4303176	25	32	16	2	64	C
16-040-25-0030099	4303177	32	40	16	2,3	64	C
16-050-25-003	4303178	40	50	16	3	41	A
16-063-25-003	4303179	50	63	16	3,5	30	A

Serie 36/84-015

Servisventil för direkt
sammansvetsning med PE-rör

NBR-Gummi

Segjärn
Epoxibeläggning
in- och utvändigt
PN 16
DN 25-50



AVK nr.	RSK nr.	DN	PE-rör	PN	Vikt	St/pall	Kod
36-032-84-16306499	4255232	25	32	16	5,1	18	A
36-040-84-16306499	4255233	32	40	16	5,5	14	B
36-050-84-163	4255234	40	50	16	5,6	12	A
36-063-84-163	4255235	50	63	16	6,8	9	A

Serie 16/54-010

POM servisventil med
dragfasta insticksuffrar för
PE-rör

NBR-Gummi

Ventilen är packad i
plastpåse

PN 16
DN 25-50



AVK nr.	RSK nr.	DN	PE-rör	PN	Vikt	St/pall	Kod
16-032-54-003	4417601	25	32	16	1,3	50	C
16-040-54-003	4417602	32	40	16	1,4	40	A
16-050-54-003	4417603	40	50	16	4,4	28	A
16-063-54-003	4417604	50	63	16	4,9	20	A

Demonteringsverktyg för PE-rör
finns på sidan 34

Serie 36/83

Slussventil med PE-rör
Spindeladapter ingår
Segjärn
NBR gummibelagd kil
epoxibeläggning
in- och utvändigt
PE 100-rör
PN 16, SDR11
DN 80-300



AVK nr.	RSK nr.	DN	PE-rör	PN	Vikt	St/pall	Kod
36-075-83-793	4417589	65	75	16	12	7	B
36-090-83-16386499	4417590	80	90	16	20	6	C
36-110-83-16386499	4417591	100	110	16	27	5	C
36-125-83-16386499	4417592	125	125	16	39	3	C
36-140-83-16386499	4417593	125	140	16	39	4	C
36-160-83-16386499	4417594	150	160	16	37	3	C
36-180-83-16386499	4417595	150	180	16	58	3	C
36-200-83-16386499	4417596	200	200	16	88	2	C
36-225-83-16386499	4417597	200	225	16	91	2	C
36-250-83-793	4417598	250	250	16	118	2	C
36-280-83-793	4417599	250	280	16	126	2	C
36-315-83-793	4417600	300	315	16	189	1	C

Serie 06/80-003

Flänsad slussventil
Spindeladapter ingår
Kort bygglängd DIN F4
Segjärn
NBR gummibelagd kil
Epoxibeläggning
in- och utvändigt
PN 10
DN 40-600



AVK nr.	RSK nr.	DN	PN	Vikt	St/pall	Kod
06-040-80-8136499	4417043	40	10	7,8	30	B
06-050-80-8136499	4417011	50	10	9	30	A
06-065-80-8136499	4417012	65	10	11	20	A
06-080-80-8136499	4417013	80	10	14	20	A
06-100-80-8136499	4417014	100	10	17	15	A
06-125-80-8136499	4417015	125	10	22	15	A
06-150-80-8136499	4417016	150	10	31	10	A
06-200-80-8036499	4417017	200	10	48	10	A
06-250-80-8036499	4417018	250	10	110	8	A
06-300-80-8036487	4417019	300	10	149	6	A
06-350-80-803	4417026	350	10	220	4	B
06-400-80-803	4417027	400	10	240	2	A
06-450-80-003	4417148	450	10	487	1	B
06-500-80-003	4417149	500	10	559	1	B
06-600-80-003	4417151	600	10	762	1	B

Serie 06/84-003

Flänsad slussventil
Kort bygglängd
DIN F4
Segjärn
NBR gummibelagd kil
Spindel AISI 316
Epoxibeläggning
in- och utvändigt
PN 10
DN 40-600

Alternativ:
- RG5 spindelmutter



AVK nr.	RSK nr.	DN	PN	Vikt	St/pall	Kod
06-040-84-0136499	4417048	40	10	7,7	34	B
06-050-84-0136499	4417049	50	10	8,52	30	A
06-065-84-0136499	4417050	65	10	10,77	25	A
06-080-84-0136499	4417052	80	10	14,4	20	A
06-100-84-0136499	4417053	100	10	16,84	20	A
06-125-84-0136499	4417054	125	10	21,77	15	A
06-150-84-0136499	4417055	150	10	30,73	10	A
06-200-84-0036499	4417056	200	10	48,17	10	A
06-250-84-0036499	4417057	250	10	102	8	A
06-300-84-0036487	4417058	300	10	110	6	A
06-350-84-003	4417059	350	10	220	2	A
06-400-84-003	4417060	400	10	240	2	A
06-450-84-003	4417061	450	10	487	1	A
06-500-84-003	4417062	500	10	559	1	A
06-600-84-003	4417063	600	10	762	1	A

Serie 06/42-001

Flänsad slussventil
kort bygglängd DIN F4
Hus av DUPLEX 1.4362
NBR gummibelagd kil
PN 10/16
DN 50-300







AVK nr.	RSK nr.	DN	PN	Vikt	St/pall	Kod
06-040-42-01395	4296936	40	10/16	8,4	30	C
06-050-42-01395	4296937	50	10/16	9,7	30	C
06-065-42-01395	4296938	65	10/16	11,5	20	C
06-080-42-01395	4296939	80	10/16	14,2	20	C
06-100-42-01395	4296940	100	10/16	16,5	15	C
06-125-42-01395	4296941	125	10/16	28	15	C
06-150-42-01395	4296942	150	10/16	31	10	C
06-200-42-00395	4296943	200	10	48	10	C
06-200-42-01395	4296944	200	16	48	10	C





Serie 06/89-003





Flänsad slussventil
med stigande spindel
Kort bygglängd DIN F4
Segjärn
EPDM gummibelagd kil
Epoxibeläggning
in- och utvändigt
PN 10
DN 50-300



AVK nr.	RSK nr.	DN	PN	Vikt	St/pall	Kod
06-050-89-014	4417034	50	10/16	19	30	C
06-065-89-014	4417035	65	10/16	22	18	C
06-080-89-014	4417036	80	10/16	24	16	C
06-100-89-014	4417037	100	10/16	33	12	A
06-125-89-014	4417038	125	10/16	41	15	C
06-150-89-014	4417039	150	10/16	53	8	C
06-200-89-004	4417040	200	10	84	8	C
06-250-89-004	4417041	250	10	95	4	C
06-300-89-004	4417042	300	10	165	4	C

<p>Serie 15/42-006 Flänsad slussventil förberedd för manöverdon Kort bygglängd DIN F4 Segjärn NBR gummibelagd kil Epoxibeläggning in- och utvändigt PN 10 DN 40-300</p> <p>Alternativ: - Elektriskt manöverdon</p> 	<table border="1"> <thead> <tr> <th>AVK nr.</th> <th>RSK nr.</th> <th>DN</th> <th>PN</th> <th>Vikt</th> <th>St/pall</th> <th>Kod</th> </tr> </thead> <tbody> <tr><td>15-050-40-013</td><td>4296925</td><td>50</td><td>10/16</td><td>14</td><td>30</td><td>A</td></tr> <tr><td>15-065-42-013</td><td>4296926</td><td>65</td><td>10/16</td><td>17</td><td>25</td><td>A</td></tr> <tr><td>15-080-42-01364099</td><td>4296927</td><td>80</td><td>10/16</td><td>21</td><td>20</td><td>A</td></tr> <tr><td>15-100-42-01364099</td><td>4296928</td><td>100</td><td>10/16</td><td>26</td><td>20</td><td>B</td></tr> <tr><td>15-125-42-01364099</td><td>4296929</td><td>125</td><td>10/16</td><td>34</td><td>15</td><td>C</td></tr> <tr><td>15-150-42-01364099</td><td>4296930</td><td>150</td><td>10/16</td><td>49</td><td>10</td><td>A</td></tr> <tr><td>15-200-42-00364099</td><td>4296931</td><td>200</td><td>10</td><td>68</td><td>10</td><td>B</td></tr> <tr><td>15-250-42-003</td><td>4296932</td><td>250</td><td>10</td><td>113</td><td>8</td><td>A</td></tr> <tr><td>15-300-42-003</td><td>4296933</td><td>300</td><td>10</td><td>160</td><td>6</td><td>A</td></tr> <tr><td>15-350-42-003</td><td>4296934</td><td>350</td><td>10</td><td>223</td><td>4</td><td>C</td></tr> <tr><td>15-400-40-003</td><td>4296935</td><td>400</td><td>10</td><td>243</td><td>2</td><td>C</td></tr> </tbody> </table>	AVK nr.	RSK nr.	DN	PN	Vikt	St/pall	Kod	15-050-40-013	4296925	50	10/16	14	30	A	15-065-42-013	4296926	65	10/16	17	25	A	15-080-42-01364099	4296927	80	10/16	21	20	A	15-100-42-01364099	4296928	100	10/16	26	20	B	15-125-42-01364099	4296929	125	10/16	34	15	C	15-150-42-01364099	4296930	150	10/16	49	10	A	15-200-42-00364099	4296931	200	10	68	10	B	15-250-42-003	4296932	250	10	113	8	A	15-300-42-003	4296933	300	10	160	6	A	15-350-42-003	4296934	350	10	223	4	C	15-400-40-003	4296935	400	10	243	2	C																				
AVK nr.	RSK nr.	DN	PN	Vikt	St/pall	Kod																																																																																																			
15-050-40-013	4296925	50	10/16	14	30	A																																																																																																			
15-065-42-013	4296926	65	10/16	17	25	A																																																																																																			
15-080-42-01364099	4296927	80	10/16	21	20	A																																																																																																			
15-100-42-01364099	4296928	100	10/16	26	20	B																																																																																																			
15-125-42-01364099	4296929	125	10/16	34	15	C																																																																																																			
15-150-42-01364099	4296930	150	10/16	49	10	A																																																																																																			
15-200-42-00364099	4296931	200	10	68	10	B																																																																																																			
15-250-42-003	4296932	250	10	113	8	A																																																																																																			
15-300-42-003	4296933	300	10	160	6	A																																																																																																			
15-350-42-003	4296934	350	10	223	4	C																																																																																																			
15-400-40-003	4296935	400	10	243	2	C																																																																																																			
<p>Serie 15/72-003 Flänsad slussventil förberedd för manöverdon Lång bygglängd DIN F5 Segjärn EPDM gummibelagd kil Epoxibeläggning in- och utvändigt PN 10 DN 40-500</p> <p>* Ökat (400 mm) genomlopp ** Reducerat (400 mm) genomlopp</p> <p>Alternativ: - Elektriskt manöverdon</p> 	<table border="1"> <thead> <tr> <th>AVK nr.</th> <th>RSK nr.</th> <th>DN</th> <th>PN</th> <th>Vikt</th> <th>St/pall</th> <th>Kod</th> </tr> </thead> <tbody> <tr><td>15-050-70-016</td><td>4255744</td><td>50</td><td>10/16</td><td>15</td><td>24</td><td>C</td></tr> <tr><td>15-065-72-016</td><td>4255745</td><td>65</td><td>10/16</td><td>18</td><td>17</td><td>C</td></tr> <tr><td>15-080-72-016</td><td>4255746</td><td>80</td><td>10/16</td><td>22</td><td>14</td><td>C</td></tr> <tr><td>15-100-72-016</td><td>4255747</td><td>100</td><td>10/16</td><td>28</td><td>12</td><td>C</td></tr> <tr><td>15-150-72-016</td><td>4255749</td><td>150</td><td>10/16</td><td>52</td><td>8</td><td>C</td></tr> <tr><td>15-200-72-006</td><td>4255750</td><td>200</td><td>10</td><td>73</td><td>6</td><td>C</td></tr> <tr><td>15-250-72-006</td><td>4255751</td><td>250</td><td>10</td><td>121</td><td>4</td><td>C</td></tr> <tr><td>15-300-72-006</td><td>4255752</td><td>300</td><td>10</td><td>171</td><td>2</td><td>C</td></tr> <tr><td>15-350-72-006 *</td><td>4255753</td><td>350</td><td>10</td><td>332</td><td>2</td><td>C</td></tr> <tr><td>15-400-72-006</td><td>4255754</td><td>400</td><td>10</td><td>353</td><td>2</td><td>C</td></tr> <tr><td>15-500-72-006 **</td><td>4255756</td><td>500</td><td>10</td><td>430</td><td>1</td><td>C</td></tr> </tbody> </table>	AVK nr.	RSK nr.	DN	PN	Vikt	St/pall	Kod	15-050-70-016	4255744	50	10/16	15	24	C	15-065-72-016	4255745	65	10/16	18	17	C	15-080-72-016	4255746	80	10/16	22	14	C	15-100-72-016	4255747	100	10/16	28	12	C	15-150-72-016	4255749	150	10/16	52	8	C	15-200-72-006	4255750	200	10	73	6	C	15-250-72-006	4255751	250	10	121	4	C	15-300-72-006	4255752	300	10	171	2	C	15-350-72-006 *	4255753	350	10	332	2	C	15-400-72-006	4255754	400	10	353	2	C	15-500-72-006 **	4255756	500	10	430	1	C																				
AVK nr.	RSK nr.	DN	PN	Vikt	St/pall	Kod																																																																																																			
15-050-70-016	4255744	50	10/16	15	24	C																																																																																																			
15-065-72-016	4255745	65	10/16	18	17	C																																																																																																			
15-080-72-016	4255746	80	10/16	22	14	C																																																																																																			
15-100-72-016	4255747	100	10/16	28	12	C																																																																																																			
15-150-72-016	4255749	150	10/16	52	8	C																																																																																																			
15-200-72-006	4255750	200	10	73	6	C																																																																																																			
15-250-72-006	4255751	250	10	121	4	C																																																																																																			
15-300-72-006	4255752	300	10	171	2	C																																																																																																			
15-350-72-006 *	4255753	350	10	332	2	C																																																																																																			
15-400-72-006	4255754	400	10	353	2	C																																																																																																			
15-500-72-006 **	4255756	500	10	430	1	C																																																																																																			
<p>Serie 715/30-003 Flänsad slussventil med Festo pneumatiskt manöverdon Incl pilotventil med lysande packning, magnetspole, spjällventil, snabbkoppling 2 x induktiva magnetgivare Kort bygglängd DIN F4 Segjärn NBR gummibelagd kil Epoxibeläggning in- och utvändigt PN 10 DN 65-300</p> 	<table border="1"> <thead> <tr> <th>AVK nr.</th> <th>RSK nr.</th> <th>DN</th> <th>PN</th> <th>Vikt</th> <th>St/pall</th> <th>Kod</th> </tr> </thead> <tbody> <tr><td>715-065-30-03009</td><td>4255601</td><td>65</td><td>10</td><td>18</td><td>6</td><td>B</td></tr> <tr><td>715-080-30-03009</td><td>4255602</td><td>80</td><td>10</td><td>22</td><td>5</td><td>B</td></tr> <tr><td>715-100-30-03009</td><td>4255603</td><td>100</td><td>10</td><td>27</td><td>6</td><td>A</td></tr> <tr><td>715-150-30-03009</td><td>4255604</td><td>150</td><td>10</td><td>52</td><td>3</td><td>A</td></tr> <tr><td>715-200-30-03009</td><td>4255605</td><td>200</td><td>10</td><td>75</td><td>2</td><td>B</td></tr> <tr><td>715-250-30-03009</td><td>4255606</td><td>250</td><td>10</td><td>112</td><td>2</td><td>C</td></tr> <tr><td>715-300-30-03009</td><td>4255607</td><td>300</td><td>10</td><td>180</td><td>1</td><td>C</td></tr> </tbody> </table>	AVK nr.	RSK nr.	DN	PN	Vikt	St/pall	Kod	715-065-30-03009	4255601	65	10	18	6	B	715-080-30-03009	4255602	80	10	22	5	B	715-100-30-03009	4255603	100	10	27	6	A	715-150-30-03009	4255604	150	10	52	3	A	715-200-30-03009	4255605	200	10	75	2	B	715-250-30-03009	4255606	250	10	112	2	C	715-300-30-03009	4255607	300	10	180	1	C																																																
AVK nr.	RSK nr.	DN	PN	Vikt	St/pall	Kod																																																																																																			
715-065-30-03009	4255601	65	10	18	6	B																																																																																																			
715-080-30-03009	4255602	80	10	22	5	B																																																																																																			
715-100-30-03009	4255603	100	10	27	6	A																																																																																																			
715-150-30-03009	4255604	150	10	52	3	A																																																																																																			
715-200-30-03009	4255605	200	10	75	2	B																																																																																																			
715-250-30-03009	4255606	250	10	112	2	C																																																																																																			
715-300-30-03009	4255607	300	10	180	1	C																																																																																																			
<p>Serie 06/35-006 Flänsad slussventil med lägesvisare Kort bygglängd DIN F4 Segjärn NBR gummibelagd kil Epoxibeläggning in- och utvändigt PN 10 DN 50-300</p> 	<table border="1"> <thead> <tr> <th>AVK nr.</th> <th>RSK nr.</th> <th>DN</th> <th>PN</th> <th>Vikt</th> <th>St/pall</th> <th>Kod</th> </tr> </thead> <tbody> <tr><td>06-050-35-013</td><td>4296945</td><td>50</td><td>10</td><td>12,5</td><td>28</td><td>A</td></tr> <tr><td>06-065-35-013</td><td>4296946</td><td>65</td><td>10</td><td>16</td><td>20</td><td>B</td></tr> <tr><td>06-080-35-013</td><td>4296947</td><td>80</td><td>10</td><td>20</td><td>18</td><td>A</td></tr> <tr><td>06-100-35-013</td><td>4296948</td><td>100</td><td>10</td><td>26,5</td><td>16</td><td>A</td></tr> <tr><td>06-125-35-013</td><td>4296949</td><td>125</td><td>10</td><td>35,5</td><td>10</td><td>A</td></tr> <tr><td>06-150-35-013</td><td>4296950</td><td>150</td><td>10</td><td>50,5</td><td>5</td><td>A</td></tr> <tr><td>06-200-35-003</td><td>4296951</td><td>200</td><td>10</td><td>71</td><td>3</td><td>A</td></tr> <tr><td>06-250-35-003</td><td>4296952</td><td>250</td><td>10</td><td>102</td><td>2</td><td>A</td></tr> <tr><td>06-300-35-003</td><td>4296953</td><td>300</td><td>10</td><td>110</td><td>2</td><td>B</td></tr> </tbody> </table>	AVK nr.	RSK nr.	DN	PN	Vikt	St/pall	Kod	06-050-35-013	4296945	50	10	12,5	28	A	06-065-35-013	4296946	65	10	16	20	B	06-080-35-013	4296947	80	10	20	18	A	06-100-35-013	4296948	100	10	26,5	16	A	06-125-35-013	4296949	125	10	35,5	10	A	06-150-35-013	4296950	150	10	50,5	5	A	06-200-35-003	4296951	200	10	71	3	A	06-250-35-003	4296952	250	10	102	2	A	06-300-35-003	4296953	300	10	110	2	B																																		
AVK nr.	RSK nr.	DN	PN	Vikt	St/pall	Kod																																																																																																			
06-050-35-013	4296945	50	10	12,5	28	A																																																																																																			
06-065-35-013	4296946	65	10	16	20	B																																																																																																			
06-080-35-013	4296947	80	10	20	18	A																																																																																																			
06-100-35-013	4296948	100	10	26,5	16	A																																																																																																			
06-125-35-013	4296949	125	10	35,5	10	A																																																																																																			
06-150-35-013	4296950	150	10	50,5	5	A																																																																																																			
06-200-35-003	4296951	200	10	71	3	A																																																																																																			
06-250-35-003	4296952	250	10	102	2	A																																																																																																			
06-300-35-003	4296953	300	10	110	2	B																																																																																																			
<p>Serie 01/80-012 Slussventil med muff för PVC-rör Spindeladapter ingår monterad med "Euro"-gummiringar Segjärn NBR gummibelagd kil Epoxibeläggning in- och utvändigt PN 16 DN 40-400</p> 	<table border="1"> <thead> <tr> <th>AVK nr.</th> <th>RSK nr.</th> <th>DN</th> <th>uPVC Utv Ø mm</th> <th>PN</th> <th>Vikt</th> <th>St/pall</th> <th>Kod</th> </tr> </thead> <tbody> <tr><td>01-050-80-013</td><td>4296709</td><td>40</td><td>50</td><td>16</td><td>7</td><td>24</td><td>B</td></tr> <tr><td>01-063-80-013</td><td>4296710</td><td>50</td><td>63</td><td>16</td><td>8</td><td>24</td><td>B</td></tr> <tr><td>01-075-80-013</td><td>4296711</td><td>65</td><td>75</td><td>16</td><td>9</td><td>19</td><td>B</td></tr> <tr><td>01-090-80-0136499</td><td>4296712</td><td>80</td><td>90</td><td>16</td><td>12</td><td>17</td><td>B</td></tr> <tr><td>01-110-80-0136499</td><td>4296713</td><td>100</td><td>110</td><td>16</td><td>15</td><td>12</td><td>B</td></tr> <tr><td>01-125-80-0136499</td><td>4296714</td><td>125</td><td>125</td><td>16</td><td>19</td><td>9</td><td>B</td></tr> <tr><td>01-160-80-0136499</td><td>4296715</td><td>150</td><td>160</td><td>16</td><td>29</td><td>7</td><td>B</td></tr> <tr><td>01-200-80-0136499</td><td>4296716</td><td>200</td><td>200</td><td>16</td><td>47</td><td>6</td><td>B</td></tr> <tr><td>01-225-80-0136499</td><td>4296717</td><td>200</td><td>225</td><td>16</td><td>50</td><td>6</td><td>B</td></tr> <tr><td>01-250-80-013</td><td>4296718</td><td>250</td><td>250</td><td>16</td><td>80</td><td>4</td><td>B</td></tr> <tr><td>01-315-80-013</td><td>4296719</td><td>300</td><td>315</td><td>16</td><td>123</td><td>2</td><td>B</td></tr> <tr><td>01-400-80-013</td><td>4296720</td><td>300</td><td>315</td><td>16</td><td>123</td><td>2</td><td>B</td></tr> </tbody> </table>	AVK nr.	RSK nr.	DN	uPVC Utv Ø mm	PN	Vikt	St/pall	Kod	01-050-80-013	4296709	40	50	16	7	24	B	01-063-80-013	4296710	50	63	16	8	24	B	01-075-80-013	4296711	65	75	16	9	19	B	01-090-80-0136499	4296712	80	90	16	12	17	B	01-110-80-0136499	4296713	100	110	16	15	12	B	01-125-80-0136499	4296714	125	125	16	19	9	B	01-160-80-0136499	4296715	150	160	16	29	7	B	01-200-80-0136499	4296716	200	200	16	47	6	B	01-225-80-0136499	4296717	200	225	16	50	6	B	01-250-80-013	4296718	250	250	16	80	4	B	01-315-80-013	4296719	300	315	16	123	2	B	01-400-80-013	4296720	300	315	16	123	2	B
AVK nr.	RSK nr.	DN	uPVC Utv Ø mm	PN	Vikt	St/pall	Kod																																																																																																		
01-050-80-013	4296709	40	50	16	7	24	B																																																																																																		
01-063-80-013	4296710	50	63	16	8	24	B																																																																																																		
01-075-80-013	4296711	65	75	16	9	19	B																																																																																																		
01-090-80-0136499	4296712	80	90	16	12	17	B																																																																																																		
01-110-80-0136499	4296713	100	110	16	15	12	B																																																																																																		
01-125-80-0136499	4296714	125	125	16	19	9	B																																																																																																		
01-160-80-0136499	4296715	150	160	16	29	7	B																																																																																																		
01-200-80-0136499	4296716	200	200	16	47	6	B																																																																																																		
01-225-80-0136499	4296717	200	225	16	50	6	B																																																																																																		
01-250-80-013	4296718	250	250	16	80	4	B																																																																																																		
01-315-80-013	4296719	300	315	16	123	2	B																																																																																																		
01-400-80-013	4296720	300	315	16	123	2	B																																																																																																		

<p>Serie 41/60-003 Backventil med klaff Mjuktätande Med fri axelände på höger sida Segjärn Epoxibeläggning in- och utvändigt PN 10 DN 50-300</p> <p>Tillbehör: 1 Arm och vikt 2 Fjädersats</p>		<table border="1"> <thead> <tr> <th>AVK nr.</th> <th>RSK nr.</th> <th>DN</th> <th>Längd</th> <th>PN</th> <th>Vikt</th> <th>St/pall</th> <th>Kod</th> </tr> </thead> <tbody> <tr><td>41-050-60-018</td><td>4425510</td><td>50</td><td>200</td><td>10/16</td><td>13</td><td>18</td><td>A</td></tr> <tr><td>41-065-60-018</td><td>4291356</td><td>65</td><td>230</td><td>10/16</td><td>16</td><td>15</td><td>A</td></tr> <tr><td>41-080-60-018</td><td>4291357</td><td>80</td><td>260</td><td>10/16</td><td>20</td><td>16</td><td>A</td></tr> <tr><td>41-100-60-018</td><td>4291358</td><td>100</td><td>300</td><td>10/16</td><td>26</td><td>12</td><td>A</td></tr> <tr><td>41-125-60-018</td><td>4291359</td><td>125</td><td>350</td><td>10/16</td><td>36</td><td>8</td><td>B</td></tr> <tr><td>41-150-60-018</td><td>4291360</td><td>150</td><td>400</td><td>10/16</td><td>51</td><td>6</td><td>A</td></tr> <tr><td>41-200-60-008</td><td>4291361</td><td>200</td><td>500</td><td>10</td><td>83</td><td>4</td><td>A</td></tr> <tr><td>41-200-60-018</td><td>4291362</td><td>200</td><td>500</td><td>16</td><td>83</td><td>4</td><td>C</td></tr> <tr><td>41-250-60-008</td><td>4291363</td><td>250</td><td>600</td><td>10</td><td>183</td><td>2</td><td>A</td></tr> <tr><td>41-250-60-018</td><td>4291364</td><td>250</td><td>600</td><td>16</td><td>183</td><td>2</td><td>C</td></tr> <tr><td>41-300-60-008</td><td>4291365</td><td>300</td><td>700</td><td>10</td><td>231</td><td>2</td><td>B</td></tr> <tr><td>41-300-60-018</td><td>4291366</td><td>300</td><td>700</td><td>16</td><td>231</td><td>2</td><td>C</td></tr> </tbody> </table>	AVK nr.	RSK nr.	DN	Längd	PN	Vikt	St/pall	Kod	41-050-60-018	4425510	50	200	10/16	13	18	A	41-065-60-018	4291356	65	230	10/16	16	15	A	41-080-60-018	4291357	80	260	10/16	20	16	A	41-100-60-018	4291358	100	300	10/16	26	12	A	41-125-60-018	4291359	125	350	10/16	36	8	B	41-150-60-018	4291360	150	400	10/16	51	6	A	41-200-60-008	4291361	200	500	10	83	4	A	41-200-60-018	4291362	200	500	16	83	4	C	41-250-60-008	4291363	250	600	10	183	2	A	41-250-60-018	4291364	250	600	16	183	2	C	41-300-60-008	4291365	300	700	10	231	2	B	41-300-60-018	4291366	300	700	16	231	2	C
AVK nr.	RSK nr.	DN	Längd	PN	Vikt	St/pall	Kod																																																																																																			
41-050-60-018	4425510	50	200	10/16	13	18	A																																																																																																			
41-065-60-018	4291356	65	230	10/16	16	15	A																																																																																																			
41-080-60-018	4291357	80	260	10/16	20	16	A																																																																																																			
41-100-60-018	4291358	100	300	10/16	26	12	A																																																																																																			
41-125-60-018	4291359	125	350	10/16	36	8	B																																																																																																			
41-150-60-018	4291360	150	400	10/16	51	6	A																																																																																																			
41-200-60-008	4291361	200	500	10	83	4	A																																																																																																			
41-200-60-018	4291362	200	500	16	83	4	C																																																																																																			
41-250-60-008	4291363	250	600	10	183	2	A																																																																																																			
41-250-60-018	4291364	250	600	16	183	2	C																																																																																																			
41-300-60-008	4291365	300	700	10	231	2	B																																																																																																			
41-300-60-018	4291366	300	700	16	231	2	C																																																																																																			
<p>Serie 41/61-003 Backventil med klaff Mjuktätande Segjärn Epoxibeläggning in- och utvändigt PN 10 DN 50-300</p> <p>Axel av rostfritt stål</p>		<table border="1"> <thead> <tr> <th>AVK nr.</th> <th>RSK nr.</th> <th>DN</th> <th>Längd</th> <th>PN</th> <th>Vikt</th> <th>St/pall</th> <th>Kod</th> </tr> </thead> <tbody> <tr><td>41-050-61-018</td><td>4291347</td><td>50</td><td>200</td><td>10</td><td>13</td><td>20</td><td>C</td></tr> <tr><td>41-065-61-018</td><td>4291348</td><td>65</td><td>230</td><td>10</td><td>17</td><td>16</td><td>C</td></tr> <tr><td>41-080-61-018</td><td>4291349</td><td>80</td><td>260</td><td>10</td><td>20</td><td>16</td><td>B</td></tr> <tr><td>41-100-61-018</td><td>4291350</td><td>100</td><td>300</td><td>10</td><td>26</td><td>12</td><td>B</td></tr> <tr><td>41-125-61-018</td><td>4291351</td><td>125</td><td>350</td><td>10</td><td>40</td><td>8</td><td>C</td></tr> <tr><td>41-150-61-018</td><td>4291352</td><td>150</td><td>400</td><td>10</td><td>51</td><td>6</td><td>C</td></tr> <tr><td>41-200-61-008</td><td>4291353</td><td>200</td><td>500</td><td>10</td><td>83</td><td>4</td><td>B</td></tr> <tr><td>41-250-61-008</td><td>4291354</td><td>250</td><td>600</td><td>10</td><td>183</td><td>2</td><td>C</td></tr> <tr><td>41-300-61-008</td><td>4291355</td><td>300</td><td>700</td><td>10</td><td>231</td><td>2</td><td>C</td></tr> </tbody> </table>	AVK nr.	RSK nr.	DN	Längd	PN	Vikt	St/pall	Kod	41-050-61-018	4291347	50	200	10	13	20	C	41-065-61-018	4291348	65	230	10	17	16	C	41-080-61-018	4291349	80	260	10	20	16	B	41-100-61-018	4291350	100	300	10	26	12	B	41-125-61-018	4291351	125	350	10	40	8	C	41-150-61-018	4291352	150	400	10	51	6	C	41-200-61-008	4291353	200	500	10	83	4	B	41-250-61-008	4291354	250	600	10	183	2	C	41-300-61-008	4291355	300	700	10	231	2	C																								
AVK nr.	RSK nr.	DN	Längd	PN	Vikt	St/pall	Kod																																																																																																			
41-050-61-018	4291347	50	200	10	13	20	C																																																																																																			
41-065-61-018	4291348	65	230	10	17	16	C																																																																																																			
41-080-61-018	4291349	80	260	10	20	16	B																																																																																																			
41-100-61-018	4291350	100	300	10	26	12	B																																																																																																			
41-125-61-018	4291351	125	350	10	40	8	C																																																																																																			
41-150-61-018	4291352	150	400	10	51	6	C																																																																																																			
41-200-61-008	4291353	200	500	10	83	4	B																																																																																																			
41-250-61-008	4291354	250	600	10	183	2	C																																																																																																			
41-300-61-008	4291355	300	700	10	231	2	C																																																																																																			
<p>Serie 41/D-001 Arm och vikt för AVK backventil med klaff Serie 41/60 Epoxibeläggning DN 50-300</p>		<table border="1"> <thead> <tr> <th>AVK nr.</th> <th>RSK nr.</th> <th>DN</th> <th>Vikt</th> <th>St/pall</th> <th>Kod</th> </tr> </thead> <tbody> <tr><td>41-080-23-000</td><td>4291333</td><td>50-80</td><td>2,5</td><td>120</td><td>A</td></tr> <tr><td>41-100-23-000</td><td>4291334</td><td>100</td><td>3,5</td><td>100</td><td>A</td></tr> <tr><td>41-150-23-000</td><td>4291335</td><td>125-150</td><td>5,2</td><td>88</td><td>B</td></tr> <tr><td>41-200-23-000</td><td>4291336</td><td>200</td><td>13</td><td>40</td><td>A</td></tr> <tr><td>41-300-23-000</td><td>4291337</td><td>250-300</td><td>13</td><td>88</td><td>A</td></tr> </tbody> </table>	AVK nr.	RSK nr.	DN	Vikt	St/pall	Kod	41-080-23-000	4291333	50-80	2,5	120	A	41-100-23-000	4291334	100	3,5	100	A	41-150-23-000	4291335	125-150	5,2	88	B	41-200-23-000	4291336	200	13	40	A	41-300-23-000	4291337	250-300	13	88	A																																																																				
AVK nr.	RSK nr.	DN	Vikt	St/pall	Kod																																																																																																					
41-080-23-000	4291333	50-80	2,5	120	A																																																																																																					
41-100-23-000	4291334	100	3,5	100	A																																																																																																					
41-150-23-000	4291335	125-150	5,2	88	B																																																																																																					
41-200-23-000	4291336	200	13	40	A																																																																																																					
41-300-23-000	4291337	250-300	13	88	A																																																																																																					
<p>Serie 41/32-001 Fjädersats för AVK backventil med klaff serie 41/60 Epoxibeläggning DN 50-300</p>		<table border="1"> <thead> <tr> <th>AVK nr.</th> <th>RSK nr.</th> <th>DN</th> <th>Vikt</th> <th>St/pall</th> <th>Kod</th> </tr> </thead> <tbody> <tr><td>41-050-32-000</td><td>4291338</td><td>50</td><td>2</td><td>88</td><td>B</td></tr> <tr><td>41-065-32-000</td><td>4291339</td><td>65</td><td>2</td><td>50</td><td>A</td></tr> <tr><td>41-080-32-000</td><td>4291340</td><td>80</td><td>3</td><td>25</td><td>A</td></tr> <tr><td>41-100-32-000</td><td>4291341</td><td>100</td><td>3,4</td><td>88</td><td>A</td></tr> <tr><td>41-125-32-000</td><td>4291342</td><td>125</td><td>3,4</td><td>88</td><td>B</td></tr> <tr><td>41-150-32-000</td><td>4291343</td><td>150</td><td>3,4</td><td>20</td><td>A</td></tr> <tr><td>41-200-32-000</td><td>4291344</td><td>200</td><td>8</td><td>88</td><td>A</td></tr> <tr><td>41-300-32-000</td><td>4291346</td><td>300</td><td>10</td><td>6</td><td>A</td></tr> </tbody> </table>	AVK nr.	RSK nr.	DN	Vikt	St/pall	Kod	41-050-32-000	4291338	50	2	88	B	41-065-32-000	4291339	65	2	50	A	41-080-32-000	4291340	80	3	25	A	41-100-32-000	4291341	100	3,4	88	A	41-125-32-000	4291342	125	3,4	88	B	41-150-32-000	4291343	150	3,4	20	A	41-200-32-000	4291344	200	8	88	A	41-300-32-000	4291346	300	10	6	A																																																		
AVK nr.	RSK nr.	DN	Vikt	St/pall	Kod																																																																																																					
41-050-32-000	4291338	50	2	88	B																																																																																																					
41-065-32-000	4291339	65	2	50	A																																																																																																					
41-080-32-000	4291340	80	3	25	A																																																																																																					
41-100-32-000	4291341	100	3,4	88	A																																																																																																					
41-125-32-000	4291342	125	3,4	88	B																																																																																																					
41-150-32-000	4291343	150	3,4	20	A																																																																																																					
41-200-32-000	4291344	200	8	88	A																																																																																																					
41-300-32-000	4291346	300	10	6	A																																																																																																					
<p>Serie 41/I-002 Skydd för arm och vikt för AVK backventil med klaff Serie 41/60</p>		<table border="1"> <thead> <tr> <th>AVK nr.</th> <th>RSK nr.</th> <th>DN</th> <th>Vikt</th> <th>St/pall</th> <th>Kod</th> </tr> </thead> <tbody> <tr><td>41-080-50-009</td><td>4291296</td><td>50-80</td><td>2</td><td>20</td><td>C</td></tr> <tr><td>41-100-50-009</td><td>4291297</td><td>100</td><td>2,2</td><td>20</td><td>C</td></tr> <tr><td>41-150-50-009</td><td>4291298</td><td>125-150</td><td>5</td><td>20</td><td>C</td></tr> <tr><td>41-200-50-009</td><td>4291299</td><td>200</td><td>7</td><td>20</td><td>C</td></tr> <tr><td>41-300-50-009</td><td>4291300</td><td>250-300</td><td>10</td><td>10</td><td>C</td></tr> </tbody> </table>	AVK nr.	RSK nr.	DN	Vikt	St/pall	Kod	41-080-50-009	4291296	50-80	2	20	C	41-100-50-009	4291297	100	2,2	20	C	41-150-50-009	4291298	125-150	5	20	C	41-200-50-009	4291299	200	7	20	C	41-300-50-009	4291300	250-300	10	10	C																																																																				
AVK nr.	RSK nr.	DN	Vikt	St/pall	Kod																																																																																																					
41-080-50-009	4291296	50-80	2	20	C																																																																																																					
41-100-50-009	4291297	100	2,2	20	C																																																																																																					
41-150-50-009	4291298	125-150	5	20	C																																																																																																					
41-200-50-009	4291299	200	7	20	C																																																																																																					
41-300-50-009	4291300	250-300	10	10	C																																																																																																					

<p>Serie 53/30-005 Backventil med kula med invändig gänga NBR gummibelagd kula Epoxibeläggning in- och utvändigt Segjärn PN 10 DN 32-50</p> 	<table border="1"> <thead> <tr> <th>AVK nr.</th> <th>RSK nr.</th> <th>DN</th> <th>BSP</th> <th>PN</th> <th>Vikt</th> <th>St/pall</th> <th>Kod</th> </tr> </thead> <tbody> <tr> <td>53-032-30-9007</td> <td>4968737</td> <td>32</td> <td>1 ¼"</td> <td>10</td> <td>2</td> <td>91</td> <td>A</td> </tr> <tr> <td>53-040-30-9007</td> <td>4968738</td> <td>40</td> <td>1 ½"</td> <td>10</td> <td>2</td> <td>91</td> <td>A</td> </tr> <tr> <td>53-050-30-9007</td> <td>4968739</td> <td>50</td> <td>2"</td> <td>10</td> <td>3</td> <td>60</td> <td>A</td> </tr> </tbody> </table>	AVK nr.	RSK nr.	DN	BSP	PN	Vikt	St/pall	Kod	53-032-30-9007	4968737	32	1 ¼"	10	2	91	A	53-040-30-9007	4968738	40	1 ½"	10	2	91	A	53-050-30-9007	4968739	50	2"	10	3	60	A																																																																																
AVK nr.	RSK nr.	DN	BSP	PN	Vikt	St/pall	Kod																																																																																																										
53-032-30-9007	4968737	32	1 ¼"	10	2	91	A																																																																																																										
53-040-30-9007	4968738	40	1 ½"	10	2	91	A																																																																																																										
53-050-30-9007	4968739	50	2"	10	3	60	A																																																																																																										
<p>Serie 53/40-005 Backventil med kula med invändig gänga NBR gummibelagd kula AISI 316 PN 10 DN 32-80</p> 	<table border="1"> <thead> <tr> <th>AVK nr.</th> <th>RSK nr.</th> <th>DN</th> <th>BSP</th> <th>PN</th> <th>Vikt</th> <th>St/pall</th> <th>Kod</th> </tr> </thead> <tbody> <tr> <td>53-032-40-9090</td> <td>4968798</td> <td>32</td> <td>1 ¼"</td> <td>10</td> <td>2</td> <td>91</td> <td>A</td> </tr> <tr> <td>53-040-40-9090</td> <td>4968799</td> <td>40</td> <td>1 ½"</td> <td>10</td> <td>2</td> <td>91</td> <td>A</td> </tr> <tr> <td>53-050-40-9090</td> <td>4968800</td> <td>50</td> <td>2"</td> <td>10</td> <td>3</td> <td>66</td> <td>A</td> </tr> <tr> <td>53-065-40-9090</td> <td>4968801</td> <td>65</td> <td>2 ½"</td> <td>10</td> <td>7</td> <td>30</td> <td>A</td> </tr> <tr> <td>53-080-40-9090</td> <td>4968802</td> <td>80</td> <td>3"</td> <td>10</td> <td>7</td> <td>30</td> <td>B</td> </tr> </tbody> </table>	AVK nr.	RSK nr.	DN	BSP	PN	Vikt	St/pall	Kod	53-032-40-9090	4968798	32	1 ¼"	10	2	91	A	53-040-40-9090	4968799	40	1 ½"	10	2	91	A	53-050-40-9090	4968800	50	2"	10	3	66	A	53-065-40-9090	4968801	65	2 ½"	10	7	30	A	53-080-40-9090	4968802	80	3"	10	7	30	B																																																																
AVK nr.	RSK nr.	DN	BSP	PN	Vikt	St/pall	Kod																																																																																																										
53-032-40-9090	4968798	32	1 ¼"	10	2	91	A																																																																																																										
53-040-40-9090	4968799	40	1 ½"	10	2	91	A																																																																																																										
53-050-40-9090	4968800	50	2"	10	3	66	A																																																																																																										
53-065-40-9090	4968801	65	2 ½"	10	7	30	A																																																																																																										
53-080-40-9090	4968802	80	3"	10	7	30	B																																																																																																										
<p>Serie 53/35-003 Backventil med kula med fläns NBR gummibelagd kula Epoxibeläggning in- och utvändigt Segjärn PN 10 DN 50-400</p> 	<table border="1"> <thead> <tr> <th>AVK nr.</th> <th>RSK nr.</th> <th>DN</th> <th>Längd</th> <th>PN</th> <th>Vikt</th> <th>St/pall</th> <th>Kod</th> </tr> </thead> <tbody> <tr> <td>53-050-35-1007</td> <td>4968730</td> <td>50</td> <td>200</td> <td>10</td> <td>7,5</td> <td>30</td> <td>A</td> </tr> <tr> <td>53-065-35-1007</td> <td>4968731</td> <td>65</td> <td>230</td> <td>10</td> <td>10</td> <td>23</td> <td>A</td> </tr> <tr> <td>53-080-35-1007</td> <td>4968732</td> <td>80</td> <td>260</td> <td>10</td> <td>12</td> <td>20</td> <td>A</td> </tr> <tr> <td>53-100-35-1007</td> <td>4968733</td> <td>100</td> <td>300</td> <td>10</td> <td>16</td> <td>15</td> <td>A</td> </tr> <tr> <td>53-125-35-1007</td> <td>4968755</td> <td>125</td> <td>350</td> <td>10</td> <td>35</td> <td>8</td> <td>B</td> </tr> <tr> <td>53-150-35-1007</td> <td>4968734</td> <td>150</td> <td>400</td> <td>10</td> <td>32</td> <td>8</td> <td>A</td> </tr> <tr> <td>53-200-35-0007</td> <td>4968735</td> <td>200</td> <td>500</td> <td>10</td> <td>68</td> <td>4</td> <td>A</td> </tr> <tr> <td>53-250-35-0007</td> <td>4968741</td> <td>250</td> <td>600</td> <td>10</td> <td>112</td> <td>4</td> <td>B</td> </tr> <tr> <td>53-300-35-0007</td> <td>4968742</td> <td>300</td> <td>700</td> <td>10</td> <td>163</td> <td>2</td> <td>B</td> </tr> <tr> <td>53-350-35-0007</td> <td>4968743</td> <td>350</td> <td>800</td> <td>10</td> <td>289</td> <td>1</td> <td>C</td> </tr> <tr> <td>53-400-35-0007</td> <td>4968744</td> <td>400</td> <td>900</td> <td>10</td> <td>416</td> <td>1</td> <td>C</td> </tr> <tr> <td>53-500-35-0007</td> <td>4968796</td> <td>500</td> <td>1100</td> <td>10</td> <td>712</td> <td>1</td> <td>C</td> </tr> <tr> <td>53-600-35-0007</td> <td>4968797</td> <td>600</td> <td>1300</td> <td>10</td> <td>1200</td> <td>1</td> <td>C</td> </tr> </tbody> </table>	AVK nr.	RSK nr.	DN	Längd	PN	Vikt	St/pall	Kod	53-050-35-1007	4968730	50	200	10	7,5	30	A	53-065-35-1007	4968731	65	230	10	10	23	A	53-080-35-1007	4968732	80	260	10	12	20	A	53-100-35-1007	4968733	100	300	10	16	15	A	53-125-35-1007	4968755	125	350	10	35	8	B	53-150-35-1007	4968734	150	400	10	32	8	A	53-200-35-0007	4968735	200	500	10	68	4	A	53-250-35-0007	4968741	250	600	10	112	4	B	53-300-35-0007	4968742	300	700	10	163	2	B	53-350-35-0007	4968743	350	800	10	289	1	C	53-400-35-0007	4968744	400	900	10	416	1	C	53-500-35-0007	4968796	500	1100	10	712	1	C	53-600-35-0007	4968797	600	1300	10	1200	1	C
AVK nr.	RSK nr.	DN	Längd	PN	Vikt	St/pall	Kod																																																																																																										
53-050-35-1007	4968730	50	200	10	7,5	30	A																																																																																																										
53-065-35-1007	4968731	65	230	10	10	23	A																																																																																																										
53-080-35-1007	4968732	80	260	10	12	20	A																																																																																																										
53-100-35-1007	4968733	100	300	10	16	15	A																																																																																																										
53-125-35-1007	4968755	125	350	10	35	8	B																																																																																																										
53-150-35-1007	4968734	150	400	10	32	8	A																																																																																																										
53-200-35-0007	4968735	200	500	10	68	4	A																																																																																																										
53-250-35-0007	4968741	250	600	10	112	4	B																																																																																																										
53-300-35-0007	4968742	300	700	10	163	2	B																																																																																																										
53-350-35-0007	4968743	350	800	10	289	1	C																																																																																																										
53-400-35-0007	4968744	400	900	10	416	1	C																																																																																																										
53-500-35-0007	4968796	500	1100	10	712	1	C																																																																																																										
53-600-35-0007	4968797	600	1300	10	1200	1	C																																																																																																										
<p>Serie 53/42-001 Backventil med kula med fläns NBR gummibelagd kula AISI316 PN 10 DN 80-150</p> 	<table border="1"> <thead> <tr> <th>AVK nr.</th> <th>RSK nr.</th> <th>DN</th> <th>Längd</th> <th>PN</th> <th>Vikt</th> <th>St/pall</th> <th>Kod</th> </tr> </thead> <tbody> <tr> <td>53-080-42-1090</td> <td>4968630</td> <td>80</td> <td>260</td> <td>10</td> <td>12</td> <td>20</td> <td>B</td> </tr> <tr> <td>53-100-42-1090</td> <td>4968631</td> <td>100</td> <td>300</td> <td>10</td> <td>16</td> <td>15</td> <td>B</td> </tr> <tr> <td>53-150-42-1090</td> <td>4968633</td> <td>150</td> <td>400</td> <td>10</td> <td>31</td> <td>8</td> <td>B</td> </tr> </tbody> </table>	AVK nr.	RSK nr.	DN	Längd	PN	Vikt	St/pall	Kod	53-080-42-1090	4968630	80	260	10	12	20	B	53-100-42-1090	4968631	100	300	10	16	15	B	53-150-42-1090	4968633	150	400	10	31	8	B																																																																																
AVK nr.	RSK nr.	DN	Längd	PN	Vikt	St/pall	Kod																																																																																																										
53-080-42-1090	4968630	80	260	10	12	20	B																																																																																																										
53-100-42-1090	4968631	100	300	10	16	15	B																																																																																																										
53-150-42-1090	4968633	150	400	10	31	8	B																																																																																																										

Serie 702/10-003

Skjutspjällventil med icke stigande spindel och handratt
Gråjärn
Epoxibeläggning
PN 10, DN 50-600

Maximalt arbetstryck:
DN 50-150: 10 bar
DN 200-250: 8 bar
DN 300-350: 6 bar
DN 400-500: 5 bar
DN 600: 4 bar

Alternativ:
Skjutspjällventil med högre arbetstryck än 6 bar

Går att få i upp till DN 1200



AVK nr.	RSK nr.	DN	PN	Vikt	Kod
702-050-10-133	4255692	50	10	6	C
702-065-10-133	4255693	65	10	7	C
702-080-10-133	4255694	80	10	13	A
702-100-10-133	4255695	100	10	15	A
702-125-10-133	4255696	125	10	19	A
702-150-10-133	4255697	150	10	26	A
702-200-10-033	4255698	200	10	43	C
702-250-10-033	4255699	250	10	58	C
702-300-10-033	4255700	300	10	83	C
702-350-10-033	4255701	350	10	107	C
702-400-10-033	4255702	400	10	140	C
702-500-10-033	4255703	500	10	260	C
702-600-10-033	4255704	600	10	340	C

Serie 702/20-003

Skjutspjällventil med stigande spindel och handratt
Epoxibeläggning
Gråjärn
PN 10, DN 50-600

Maximalt arbetstryck:
DN 50-150: 10 bar
DN 200-400: 6 bar
DN 400-500: 5 bar
DN 600: 4 bar

Alternativ:
Skjutspjällventil med högre arbetstryck än 6 bar

Går att få i upp till DN 1200



AVK nr.	RSK nr.	DN	PN	Vikt	Kod
702-050-20-134	4255705	50	10	6	C
702-065-20-134	4255706	65	10	7	C
702-080-20-134	4255707	80	10	12	C
702-100-20-134	4255708	100	10	15	C
702-125-20-134	4255709	125	10	19	C
702-150-20-134	4255710	150	10	26	C
702-200-20-034	4255711	200	10	43	C
702-250-20-034	4255712	250	10	58	C
702-300-20-034	4255713	300	10	83	C
702-350-20-034	4255800	350	10	107	C
702-400-20-034	4255714	400	10	140	C
702-500-20-034	4255715	500	10	260	C
702-600-20-034	4255716	600	10	340	C

Serie 702/30-003

Skjutspjäll med snabböppning/stängning
Epoxibeläggning
Gråjärn
PN 10
DN 50-200



AVK nr.	RSK nr.	DN	PN	Vikt	Kod
702-050-30-134	4255797	50	10	7	C
702-065-30-134	4255798	65	10	9	C
702-080-30-134	4255740	80	10	15	C
702-100-30-134	4255741	100	10	17	C
702-125-30-134	4255742	125	10	23	C
702-150-30-134	4255743	150	10	28	C
702-200-30-034	4255799	200	10	46	C

Serie 702/40-003

Skjutspjällventil med pneumatiskt manöverdon
Epoxibeläggning
Gråjärn
PN 10, DN 50-600

Maximalt arbetstryck:
DN 50-150: 10 bar
DN 200-400: 6 bar
DN 400-600 5 bar

Alternativ:
Skjutspjällventil med högre arbetstryck än 6 bar

Går att få i upp till DN 1200



AVK nr.	RSK nr.	DN	PN	Vikt	Kod
702-050-40-134	4255717	50	10	8	C
702-080-40-134	4255719	80	10	13	A
702-100-40-134	4255720	100	10	15	A
702-125-40-134	4255721	125	10	20	A
702-150-40-134	4255722	150	10	31	A
702-200-40-034	4255723	200	10	48	C
702-250-40-034	4255724	250	10	63	C
702-300-40-034	4255725	300	10	93	C
702-350-40-034	4255726	350	10	134	C
702-400-40-034	4255727	400	10	170	C
702-450-40-034	4255801	450	10	260	C
702-500-40-034	4255802	500	10	315	C

Serie 702/50-003

Skjutspjällventil
med ISO- fläns förberedd för
elektriskt manöverdon
Med stigande spindel
Epoxibeläggning
Gråjärn
PN 10, DN 50-600



Maximalt arbetstryck:
DN 50-150: 10 bar
DN 200-400: 6 bar
DN 400-600: 5 bar

Alternativ:
Skjutspjällventil med högre
arbetstryck än 6 bar

Går att få i upp till DN 1200

AVK nr.	RSK nr.	DN	PN	Vikt	Kod
702-050-50-134	4255728	50	10	7	C
702-080-50-134	4255730	80	10	13	C
702-100-50-134	4255731	100	10	15	C
702-150-50-134	4255733	150	10	28	C
702-200-50-034	4255734	200	10	35	C
702-250-50-034	4255735	250	10	58	C
702-300-50-034	4255736	300	10	35	C
702-350-50-034	4255737	350	10	125	C
702-400-50-034	4255738	400	10	145	C
702-500-50-034	4255803	500	10	270	C
702-600-50-034	4255804	600	10	360	C

Serie 702/70-003

Skjutspjällventil
med elektriskt manöverdon
Med stigande spindel
Epoxibeläggning
Gråjärn
PN 10
DN 50-600



Maximalt arbetstryck:
DN 50-150: 10 bar
DN 200-350: 6 bar
DN 400-600: 5 bar

Alternativ:
Skjutspjällventil med högre
arbetstryck än 6 bar

DN 50-200: AUMA SA 07 5, F10
DN 250-400: AUMA SA 10 1, F10
DN 450-600: AUMA SA 14, 1, F14

AVK nr.	RSK nr.	DN	PN	Vikt	Kod
702-050-70134	4255627	50	10	22	C
702-065-70134	4255628	65	10	23	C
702-080-70134	4255629	80	10	26	C
702-100-70134	4255630	100	10	18	C
702-125-70134	4255631	125	10	30	C
702-150-70134	4255632	150	10	28	C
702-200-70034	4255633	200	10	55	C
702-250-70034	4255634	250	10	85	C
702-300-70034	4255635	300	10	107	C
702-350-70034	4255636	350	10	150	C
702-400-70034	4255637	400	10	170	C
702-450-70034	4255638	450	10	250	C
702-500-70034	4255639	500	10	300	C
702-600-70034	4255640	600	10	390	C







Serie 772/00

Väggmonterad slusslucka
DN 200-1000
Rostfri ram Glidlager av
UHMWPE för lågt
öppnings och
stängningsmoment
Tätthetsklass 5 (1,2 l/min
per tätningsmeter)
4-sidigt tätande



Alternativ:
Kanalslusslucka

AVK nr.	DN	Kod
	200	C
	300	C
	400	C
	500	C
	600	C
	700	C
	800	C
	900	C
	1000	C
	1100	C
	1200	C

<p>Serie 701/70-010 Kombinations- avluftsventil Epoxibeläggning 0,2 - 16 bar PN 16 DN 50-200</p> 	<table border="1"> <thead> <tr> <th>AVK nr.</th> <th>RSK nr.</th> <th>DN</th> <th>BSP</th> <th>PN</th> <th>Vikt</th> <th>St/pall</th> <th>Kod</th> </tr> </thead> <tbody> <tr> <td>701-050-70-11003</td> <td>4287666</td> <td>50</td> <td></td> <td>16</td> <td>17</td> <td>9</td> <td>C</td> </tr> <tr> <td>701-051-70-91003</td> <td>4287649</td> <td>50</td> <td>2"</td> <td>16</td> <td>16</td> <td>6</td> <td>B</td> </tr> <tr> <td>701-080-70-11003</td> <td>4287667</td> <td>80</td> <td></td> <td>16</td> <td>18</td> <td>12</td> <td>C</td> </tr> <tr> <td>701-100-70-11003</td> <td>4287671</td> <td>100</td> <td></td> <td>16</td> <td>19</td> <td>9</td> <td>C</td> </tr> <tr> <td>701-150-70-11003</td> <td>4287672</td> <td>150</td> <td></td> <td>16</td> <td>21</td> <td>9</td> <td>C</td> </tr> <tr> <td>701-200-70-11003</td> <td>4287673</td> <td>200</td> <td></td> <td>16</td> <td>24</td> <td>5</td> <td>C</td> </tr> <tr> <td>701-200-70-01003</td> <td>4287809</td> <td>200</td> <td></td> <td>10</td> <td>24</td> <td>5</td> <td>C</td> </tr> </tbody> </table>	AVK nr.	RSK nr.	DN	BSP	PN	Vikt	St/pall	Kod	701-050-70-11003	4287666	50		16	17	9	C	701-051-70-91003	4287649	50	2"	16	16	6	B	701-080-70-11003	4287667	80		16	18	12	C	701-100-70-11003	4287671	100		16	19	9	C	701-150-70-11003	4287672	150		16	21	9	C	701-200-70-11003	4287673	200		16	24	5	C	701-200-70-01003	4287809	200		10	24	5	C																										
AVK nr.	RSK nr.	DN	BSP	PN	Vikt	St/pall	Kod																																																																																				
701-050-70-11003	4287666	50		16	17	9	C																																																																																				
701-051-70-91003	4287649	50	2"	16	16	6	B																																																																																				
701-080-70-11003	4287667	80		16	18	12	C																																																																																				
701-100-70-11003	4287671	100		16	19	9	C																																																																																				
701-150-70-11003	4287672	150		16	21	9	C																																																																																				
701-200-70-11003	4287673	200		16	24	5	C																																																																																				
701-200-70-01003	4287809	200		10	24	5	C																																																																																				
<p>Serie 701/75-010 Kort kombinations- avluftsventil Nylon PN 10 DN 50-100</p> 	<table border="1"> <thead> <tr> <th>AVK nr.</th> <th>RSK nr.</th> <th>DN</th> <th>BSP</th> <th>PN</th> <th>Vikt</th> <th>St/pall</th> <th>Kod</th> </tr> </thead> <tbody> <tr> <td>701-050-75-09001</td> <td>4287661</td> <td>50</td> <td></td> <td>10</td> <td>4,2</td> <td>30</td> <td>C</td> </tr> <tr> <td>701-051-75-09001</td> <td>4287664</td> <td>50</td> <td>2"</td> <td>10</td> <td>3,7</td> <td>12</td> <td>A</td> </tr> <tr> <td>701-080-75-09001</td> <td>4287663</td> <td>80</td> <td></td> <td>10</td> <td>4,3</td> <td>12</td> <td>B</td> </tr> <tr> <td>701-081-75-09001</td> <td>4287665</td> <td>80</td> <td>3"</td> <td>10</td> <td>3,8</td> <td>30</td> <td>C</td> </tr> <tr> <td>701-100-75-09001</td> <td>4287677</td> <td>100</td> <td></td> <td>10</td> <td>6</td> <td>20</td> <td>B</td> </tr> </tbody> </table>	AVK nr.	RSK nr.	DN	BSP	PN	Vikt	St/pall	Kod	701-050-75-09001	4287661	50		10	4,2	30	C	701-051-75-09001	4287664	50	2"	10	3,7	12	A	701-080-75-09001	4287663	80		10	4,3	12	B	701-081-75-09001	4287665	80	3"	10	3,8	30	C	701-100-75-09001	4287677	100		10	6	20	B																																										
AVK nr.	RSK nr.	DN	BSP	PN	Vikt	St/pall	Kod																																																																																				
701-050-75-09001	4287661	50		10	4,2	30	C																																																																																				
701-051-75-09001	4287664	50	2"	10	3,7	12	A																																																																																				
701-080-75-09001	4287663	80		10	4,3	12	B																																																																																				
701-081-75-09001	4287665	80	3"	10	3,8	30	C																																																																																				
701-100-75-09001	4287677	100		10	6	20	B																																																																																				
<p>Serie 701/78-010 Extra stor kombinations- avluftsventil Kran på sidan för dränering och spolning Epoxibeläggning PN 10/16 DN 50-200</p> 	<table border="1"> <thead> <tr> <th>AVK nr.</th> <th>RSK nr.</th> <th>DN</th> <th>PN</th> <th>Vikt</th> <th>Kod</th> </tr> </thead> <tbody> <tr> <td>701-080-78-11003</td> <td>4287763</td> <td>80</td> <td>10/16</td> <td>25</td> <td>C</td> </tr> <tr> <td>701-100-78-11003</td> <td>4287764</td> <td>100</td> <td>10/16</td> <td>27</td> <td>C</td> </tr> <tr> <td>701-150-78-11003</td> <td>4287765</td> <td>150</td> <td>10/16</td> <td>28</td> <td>C</td> </tr> <tr> <td>701-200-78-01003</td> <td>4287766</td> <td>200</td> <td>10</td> <td>30</td> <td>C</td> </tr> <tr> <td>701-200-78-11003</td> <td>4287767</td> <td>200</td> <td>16</td> <td>30</td> <td>C</td> </tr> </tbody> </table>	AVK nr.	RSK nr.	DN	PN	Vikt	Kod	701-080-78-11003	4287763	80	10/16	25	C	701-100-78-11003	4287764	100	10/16	27	C	701-150-78-11003	4287765	150	10/16	28	C	701-200-78-01003	4287766	200	10	30	C	701-200-78-11003	4287767	200	16	30	C																																																						
AVK nr.	RSK nr.	DN	PN	Vikt	Kod																																																																																						
701-080-78-11003	4287763	80	10/16	25	C																																																																																						
701-100-78-11003	4287764	100	10/16	27	C																																																																																						
701-150-78-11003	4287765	150	10/16	28	C																																																																																						
701-200-78-01003	4287766	200	10	30	C																																																																																						
701-200-78-11003	4287767	200	16	30	C																																																																																						
<p>Serie 970/A Isoleringshätta med kapp För Serie 701/75 D-025</p> 	<table border="1"> <tbody> <tr> <td>* N/A</td> <td>N/A</td> </tr> </tbody> </table>	* N/A	N/A																																																																																								
* N/A	N/A																																																																																										
<p>Serie 701/79-011 Avluftare komplett med brunn Höjd 1170 mm DN 80-100</p>  <p>Serie 701/79-010 Avluftare komplett med brunn Höjd 970 mm DN 80-100</p>	<table border="1"> <thead> <tr> <th>AVK nr.</th> <th>RSK nr.</th> <th>DN</th> <th>Variant</th> <th>Vikt</th> <th>Kod</th> </tr> </thead> <tbody> <tr> <td colspan="6">* Höjd 1170 mm</td> </tr> <tr> <td>701-084-79-190010</td> <td>4287803</td> <td>80</td> <td>3" gänga, nylon</td> <td>39</td> <td>C</td> </tr> <tr> <td>701-085-79-190010</td> <td>4287804</td> <td>80</td> <td>3" gänga, rostfritt stål</td> <td>39</td> <td>C</td> </tr> <tr> <td>701-086-79-190013</td> <td>4287805</td> <td>80</td> <td>Flänsad, nylon</td> <td>39</td> <td>C</td> </tr> <tr> <td>701-087-79-190013</td> <td>4287806</td> <td>80</td> <td>Flänsad, rostfritt stål</td> <td>39</td> <td>C</td> </tr> <tr> <td>701-102-79-190013</td> <td>4287807</td> <td>100</td> <td>Flänsad, nylon</td> <td>39</td> <td>C</td> </tr> <tr> <td>701-103-79-190013</td> <td>4287808</td> <td>100</td> <td>Flänsad, rostfritt stål</td> <td>39</td> <td>C</td> </tr> <tr> <td colspan="6">* Höjd 970 mm</td> </tr> <tr> <td>701-080-79-190010</td> <td>4287825</td> <td>80</td> <td>3" gänga, nylon</td> <td>38</td> <td>C</td> </tr> <tr> <td>701-081-79-190010</td> <td>4287826</td> <td>80</td> <td>3" gänga, rostfritt stål</td> <td>38</td> <td>C</td> </tr> <tr> <td>701-082-79-190013</td> <td>4287827</td> <td>80</td> <td>Flänsad, nylon</td> <td>38</td> <td>C</td> </tr> <tr> <td>701-083-79-190013</td> <td>4287828</td> <td>80</td> <td>Flänsad, rostfritt stål</td> <td>38</td> <td>C</td> </tr> <tr> <td>701-100-79-190013</td> <td>4287829</td> <td>100</td> <td>Flänsad, nylon</td> <td>38</td> <td>C</td> </tr> <tr> <td>701-101-79-190013</td> <td>4287830</td> <td>100</td> <td>Flänsad, rostfritt stål</td> <td>38</td> <td>C</td> </tr> </tbody> </table>	AVK nr.	RSK nr.	DN	Variant	Vikt	Kod	* Höjd 1170 mm						701-084-79-190010	4287803	80	3" gänga, nylon	39	C	701-085-79-190010	4287804	80	3" gänga, rostfritt stål	39	C	701-086-79-190013	4287805	80	Flänsad, nylon	39	C	701-087-79-190013	4287806	80	Flänsad, rostfritt stål	39	C	701-102-79-190013	4287807	100	Flänsad, nylon	39	C	701-103-79-190013	4287808	100	Flänsad, rostfritt stål	39	C	* Höjd 970 mm						701-080-79-190010	4287825	80	3" gänga, nylon	38	C	701-081-79-190010	4287826	80	3" gänga, rostfritt stål	38	C	701-082-79-190013	4287827	80	Flänsad, nylon	38	C	701-083-79-190013	4287828	80	Flänsad, rostfritt stål	38	C	701-100-79-190013	4287829	100	Flänsad, nylon	38	C	701-101-79-190013	4287830	100	Flänsad, rostfritt stål	38	C
AVK nr.	RSK nr.	DN	Variant	Vikt	Kod																																																																																						
* Höjd 1170 mm																																																																																											
701-084-79-190010	4287803	80	3" gänga, nylon	39	C																																																																																						
701-085-79-190010	4287804	80	3" gänga, rostfritt stål	39	C																																																																																						
701-086-79-190013	4287805	80	Flänsad, nylon	39	C																																																																																						
701-087-79-190013	4287806	80	Flänsad, rostfritt stål	39	C																																																																																						
701-102-79-190013	4287807	100	Flänsad, nylon	39	C																																																																																						
701-103-79-190013	4287808	100	Flänsad, rostfritt stål	39	C																																																																																						
* Höjd 970 mm																																																																																											
701-080-79-190010	4287825	80	3" gänga, nylon	38	C																																																																																						
701-081-79-190010	4287826	80	3" gänga, rostfritt stål	38	C																																																																																						
701-082-79-190013	4287827	80	Flänsad, nylon	38	C																																																																																						
701-083-79-190013	4287828	80	Flänsad, rostfritt stål	38	C																																																																																						
701-100-79-190013	4287829	100	Flänsad, nylon	38	C																																																																																						
701-101-79-190013	4287830	100	Flänsad, rostfritt stål	38	C																																																																																						
<p>Serie 701/78-026 Extra stor kombinations- avluftsventil Hus av förstärkt nylon 0,1 - 16 bar DN 50-200 Flänsad eller med utvändig gänga</p> 	<table border="1"> <thead> <tr> <th>AVK nr.</th> <th>RSK nr.</th> <th>DN</th> <th>BSP</th> <th>PN bar</th> <th>Vikt</th> </tr> </thead> <tbody> <tr> <td>970-0703-015-00081</td> <td>4294979</td> <td>50</td> <td></td> <td>0,1-16</td> <td>8,1</td> </tr> <tr> <td>970-0703-015-00085</td> <td>4294980</td> <td>50</td> <td>2"</td> <td>0,1-16</td> <td>8,5</td> </tr> </tbody> </table>	AVK nr.	RSK nr.	DN	BSP	PN bar	Vikt	970-0703-015-00081	4294979	50		0,1-16	8,1	970-0703-015-00085	4294980	50	2"	0,1-16	8,5																																																																								
AVK nr.	RSK nr.	DN	BSP	PN bar	Vikt																																																																																						
970-0703-015-00081	4294979	50		0,1-16	8,1																																																																																						
970-0703-015-00085	4294980	50	2"	0,1-16	8,5																																																																																						

Serie 06/70-003

Flänsad slussventil
Kort bygglängd DIN F4
Segjärn
Epoxymålning in och
utvändigt (Gul Ral 1023)
Class II
Utbyttbar spindelpackning
PN 10/16
DN 40-600



AVK nr.	RSK nr.	DN	PN	Vikt	St/pall	Kod
06-040-70-01237	4417071	40	10/16	10	30	B
06-050-70-01237	4417083	50	10/16	10	30	A
06-065-70-01237	4417072	65	10/16	13	25	B
06-080-70-01237	4417073	80	10/16	15	20	A
06-100-70-01237	4417074	100	10/16	22	20	A
06-125-70-01237	4417075	125	10/16	27	15	B
06-150-70-01237	4417076	150	10/16	36	10	A
06-200-70-00237	4417152	200	10	52	10	B
06-200-70-01237	4417064	200	16	54	10	B
06-250-70-00237	4417065	250	10	79	8	B
06-250-70-01237	4417066	250	16	80	8	B
06-300-70-00237	4417067	300	10	116	6	C
06-300-70-01237	4417068	300	16	116	6	A
06-350-70-00337	4417069	350	10	220	2	C
06-350-70-01237	4417153	350	16	220	4	C
06-400-70-00337	4417070	400	10	240	2	B
06-400-70-01337	4417154	400	16	240	2	B
06-450-70-00337	4417155	450	10	487	1	C
06-450-70-01337	4417156	450	16	487	1	C
06-500-70-00337	4417157	500	10	559	1	A
06-500-70-01337	4417158	500	16	559	1	C
06-600-70-00337	4417159	600	10	762	1	C
06-600-70-01337	4417160	600	16	762	1	C

Serie 36/90-170

Ventil med PE-rör
För direkt sammansvetsning
med PE-rör
Segjärn
Epoxymålning
in och utvändigt
(Gul Ral 1023)
Class II
Utbyttbar spindelpackning
PE 100 / SDR11
PN 10
DN 80-400



AVK nr.	RSK nr.	DN	PE-rör	PN	Vikt	St/pall	Kod
36-090-90-703037	4255611	80	90	10	20	6	A
36-110-90-703037	4255612	100	110	10	27	5	A
36-125-90-703037	4255613	125	125	10	39	4	A
36-160-90-703037	4255614	150	160	10	52	3	A
36-180-90-703037	4255615	150	180	10	58	3	A
36-200-90-703037	4255616	200	200	10	88	2	A
36-225-90-703037	4255617	200	225	10	91	2	A
36-250-90-703037	4255572	250	250	10	118	2	A
36-280-90-703037	4255619	250	280	10	126	2	B
36-315-90-703037	4255620	300	315	10	140	1	A
36-355-90-703037	4255643	350	355	10	270	1	B
36-400-90-703037	4255644	400	400	10	376	1	B

Serie 03/25-004

Servisventil
Segjärn
Epoxymålning in och
utvändigt (Gul Ral 1023)
Class II
Utbyttbar spindelpackning
Invändig gänga BSP
PN 4
DN 25-50



AVK nr.	RSK nr.	DN	Dd mm	BSP	PN	Vikt	St/pall	Kod
03-032-25-00237	4255421	25	32	1"	4	3	96	B
03-040-25-00237	4255422	32	40	1¼"	4	3	80	B
03-050-25-00237	4255423	40	50	1½"	4	5,2	55	B
03-063-25-00237	4255424	50	63	2"	4	6	48	B

Serie 36/9X-170

Servisventil med med PE-ändar
För direkt sammansvetsning med
PE-rör
Segjärn
Epoxymålning in
och utvändigt
(Gul Ral 1023)
Class II
Utbyttbar spindelpackning
PE 100
PN 4
DN 25-50



AVK nr.	RSK nr.	DN	PE-rör	PN	Vikt	St/pall	Kod
36-032-90-703037	4255407	25	32	10	5,1	18	A
36-040-90-703037	4255408	32	40	10	5,5	14	B
36-050-90-703037	4255409	40	50	10	7,1	12	A
36-063-90-703037	4255420	50	63	10	8	9	A

Serie 79-002

Flänspackning med stål kärna
Stål
NBR gummi
rak "KGS" design
PN 10-40 / 10/16 / 10
DN 50-800



AVK nr.	RSK nr.	DN	Dimension	Vikt	St/bunt	Kod
79-050-2-42	1508117	50	107 x 61 x 4 mm	0,341	20	A
79-065-2-42	1508119	65	127 x 77 x 4 mm	0,448	20	A
79-080-2-42	1508120	80	142 x 89 x 4 mm	0,691	20	A
79-100-2-22	1508121	100	162 x 115 x 5 mm	0,804	20	A
79-125-2-22	1508122	125	192 x 141 x 5 mm	0,106	20	A
79-150-2-22	1508123	150	218 x 169 x 5 mm	0,122	20	A
79-200-2-22	1508124	200	273 x 220 x 6 mm	0,18	20	A
79-250-2-12	1508125	250	328 x 273 x 6 mm	0,3	20	A
79-300-2-12	1508127	300	378 x 324 x 6 mm	0,3	20	A
79-350-2-12	1508128	350	438x 356 x 7 mm	0,48	10	B
79-400-2-12	1508129	400	489 x 407 x 7 mm	0,74	10	A
79-450-2-12	1508130	450	539 x 458 x 7 mm	1	10	C
79-500-2-12	1508131	500	594 x 508 x 7 mm	1	10	C
79-600-2-12	1508132	600	695 x 610 x 7 mm	1,06	10	C
79-700-2-12	1508133	700	810 x 712 x 8 mm	1,5	10	C
79-800-2-12	1508135	800	820 x 813 x 8 mm	2,16	10	C

Serie 79-004

Flänspackning med stål kärna
Stål
NBR gummi
droppformad "KGS-S" design
PN 10-40 / 10/16 / 10
DN 50-800



AVK nr.	RSK nr.	DN	Dimension	Vikt	St/bunt	Kod
79-050-2-43	1508153	50	107 x 61 x 4 mm	0,341	10	C
79-065-2-43	1508154	65	127 x 77 x 4 mm	0,448	10	C
79-080-2-43	1508155	80	142 x 89 x 4 mm	0,691	10	C
79-100-2-23	1508156	100	162 x 115 x 5 mm	0,804	10	C
79-125-2-23	1508157	125	192 x 141 x 5 mm	0,106	10	C
79-150-2-23	1508158	150	218 x 169 x 5 mm	0,122	10	C
79-200-2-23	1508160	200	273 x 220 x 6 mm	0,18	10	C
79-250-2-13	1508161	250	328 x 273 x 6 mm	0,3	10	C
79-300-2-13	1508162	300	378 x 324 x 6 mm	0,3	10	C
79-350-2-13	1508163	350	438x 356 x 7 mm	0,48	20	C
79-400-2-13	1508164	400	489 x 407 x 7 mm	0,74	20	C
79-450-2-13	1508165	450	539 x 458 x 7 mm	1	20	C
79-500-2-13	1508166	500	594 x 508 x 7 mm	1	20	C
79-600-2-13	1508168	600	695 x 610 x 7 mm	1,06	20	C
79-700-2-13	1508169	700	810 x 712 x 8 mm	1,5	20	C
79-800-2-13	1508170	800	820 x 813 x 8 mm	2,16	20	C

Serie 85/30-002

Certus kulventil för vatten,
avlopp och gas
PE 100 ventil
PN 10, SDR11
DVGW och WRAS godkänt
Tätningar av NBR-gummi
Axel av POM och PA



AVK nr.	RSK nr.	DN	PE-rör	PN	Vikt	Kod
85-020-30-23203001	5495366	25	20	10	0,8	C
85-032-30-23203001	5495367	25	32	10	0,8	C
85-040-30-13203001	5495368	32	40	10	0,9	C
85-063-30-23203001	5495369	50	63	10	1,8	C
85-090-30-23203001	5495370	80	75	10	3,8	C
85-110-30-21203001	5495371	100	90	10	5,5	C
85-125-30-11203001	5495372	100	110	10	5,9	C
85-160-30-21203001	5495373	150	125	10	13,8	C
85-180-30-11203001	5495374	150	160	10	14,4	C

Serie 04/F-31

Teleskopiskt garnityr för
AVK's Certus kulventil
Galvaniserat rör



AVK nr.	RSK nr.	För Ø mm	L mm	Vikt	St/pall	Kod
04-032-2-00030033	4219694	20-63	450-700	5,8		C
04-032-2-05030033	4219695	20-63	650-1100	6		C
04-032-2-10030033	4219696	20-63	1050-1750	6,4		C
04-032-2-15030033	4219697	20-63	1700-2900	6,9		C
04-080-2-00020033	4219698	90	450-700	5,8		C
04-080-2-05020033	4219699	90	650-1100	6		C
04-080-2-10020033	4219700	90	1050-1750	6,4		C
04-080-2-15020033	4219701	90	1700-2900	6,9		C
04-100-2-00020033	4219702	110-125	450-700	5,8		C
04-100-2-05020033	4219703	110-125	650-1100	6		C
04-100-2-10020033	4219704	110-125	1050-1750	6,4		C
04-100-2-15020033	4219705	110-125	1700-2900	6,9		C
04-150-2-00020033	4219706	160-180	450-700	5,8		C
04-150-2-05020033	4219707	160-180	650-1100	6		C
04-150-2-10020033	4219708	160-180	1050-1750	6,4		C
04-150-2-15020033	4219709	160-180	1700-2900	6,9		C

Serie 80/31

Betäckning "FUTURA"
för gas.
Finns med både rund och
fyrkantig ram.



AVK nr.		Vikt	Kod
80-31-011-0001	SVART SEGJÄRN PROPP "GAS"	3,8	C
80-31-014-0001	SVART PP-PROPP "GAS"	2,2	C
80-31-014-0004	GULT PP-PROPP "GAS"	2,2	C

AVK nr.		Vikt	Kod
80-31-211-0001	SVART SEGJÄRN PROPP "GAS"	3,8	C
80-31-214-0002	SVART PP-PROPP "GAS"	2,2	C
80-31-214-0007	GULT PP-PROPP "GAS"	2,2	C

Serie 80/32

Låsbar betäckning



AVK nr.		Vikt	Kod
80-32-000-1002	SVART SEGJÄRN PROPP "W"	3,3	B
94-250-0910	NYCKEL	0,01	B

Supportplatta för
fixering av garnityr
och underlägg för
betäckning



AVK nr.		Vikt	Kod
80-46-000-01	SUPPORTPLATTA	0,785	

Serie 06/35-013

Flänsad slussventil med lägesvisare och handdrätt
Kort bygglängd DIN F4
EPDM gummibelagd kil
Segjärn
Epoxibeläggning
in- och utvändigt
Ral 3000 (röd)
PN 10/16
DN 50-300



AVK nr.	RSK nr.	DN	PN	Vikt	St/pall	Kod
06-050-35-01420	4417130	50	10/16	13	28	C
06-065-35-01420	4417131	65	10/16	16	22	C
06-080-35-01420	4417132	80	10/16	20	18	C
06-100-35-01420	4417133	100	10/16	27	16	C
06-125-35-01420	4417134	125	10/16	36	6	C
06-150-35-01420	4417135	150	10/16	50	5	C
06-200-35-00620	4417136	200	10	71	3	C
06-200-35-01620	4417137	200	16	71	3	C
06-250-35-00620	4417138	250	10	108	2	C
06-250-35-01620	4417139	250	16	108	2	C
06-300-35-00620	4417140	300	10	116	2	C
06-300-35-01620	4417141	300	16	116	2	C

Serie 45/56-001

Flänsad slussventil med stigande spindel
Kilen är fullt vulkaniserad av EPDM gummi

Andra flänsborringar kan fås



AVK nr.	DN	D mm	PN	Vikt	St/pall	Kod
45-065-56-01614020 ¹	65	229	10/16	23	9	C
45-080-56-01614020 ¹	80	229	10/16	25	8	C
45-100-56-01614020 ¹	100	279	10/16	39	6	C
45-150-56-01614020 ¹	150	330	10/16	63	3	C
45-200-56-01614020 ¹	200	356	10	97	2	C
45-200-56-00614020 ¹	200	356	16	97	2	C
45-250-56-01604020 ¹	250	457	10	157	2	C
45-250-56-01604020 ¹	250	457	16	157	2	C
45-300-5C-01604020 ²	300	457	10	238	2	C
45-300-5C-01614020 ³	300	457	16	238	2	C

¹ UL och FM-godkänd
² Spindel i aluminium brons. UL/FM godkänd.
³ Spindel i aluminium brons.

Serie 75/31-023

Vridspjäll för brandsystem med växel
PN10/16



AVK nr.	DN	PN	Vikt	Kod
75-0050-30-214202600204	50	10/16	2,8	C
75-0065-30-214202600204	65	10/16	3,6	C
75-0080-30-214202600204	80	10/16	3,9	C
75-0100-30-214202600204	100	10/16	5,1	C
75-0125-30-214202600204	125	10/16	7	C
75-0150-30-214202600204	150	10/16	9,5	C
75-0200-30-214202600204	200	10	14	C
75-0250-30-214201300204	250	10	24	C
75-0250-30-214202600204	250	16	24	C
75-0300-30-214201300204	300	10	36	C
75-0300-30-214202600204	300	16	36	C





Serie 06/37-003





Slussventil med rilländar
Lägesvisare



AVK nr.	RSK nr.	DN	Ø mm	PN	Vikt	St/pall	Kod
06-050-37-09620	4417582	50	60	10/16	10	28	C
06-080-37-09620	4417583	80	89	10/16	15	20	C
06-100-37-09620	4417584	100	114	10/16	22	16	C
06-150-37-09620	4417585	150	168	10/16	44	5	C
06-200-37-09620	4417586	200	219	16	61	2	C
06-250-37-09620	4417587	250	273	16	94	2	C
06-300-37-09620	4417588	300	324	16	126	2	C

DIN / PRODUKTER FÖR BRANDBEKÄMPNING

<p>Serie 05/E-009 Stödhylsa för PE-rör PE 100, PN 10 63-400 mm SDR 17 Hel hylsa utan kil</p> 	<table border="1"> <thead> <tr> <th>AVK nr.</th> <th>RSK nr.</th> <th>DN</th> <th>Dd</th> <th>PN</th> <th>Vikt</th> <th>St/pall</th> <th>Kod</th> </tr> </thead> <tbody> <tr><td>05-063-83000</td><td>2557861</td><td>50</td><td>63</td><td>16</td><td>0,2</td><td>432</td><td>B</td></tr> <tr><td>05-075-83000</td><td>2557862</td><td>65</td><td>75</td><td>16</td><td>0,3</td><td>300</td><td>A</td></tr> <tr><td>05-090-83000</td><td>2557863</td><td>80</td><td>90</td><td>16</td><td>0,3</td><td>208</td><td>A</td></tr> <tr><td>05-110-83000</td><td>2557864</td><td>100</td><td>110</td><td>16</td><td>0,4</td><td>140</td><td>A</td></tr> <tr><td>05-125-83000</td><td>2557865</td><td>125</td><td>125</td><td>16</td><td>0,4</td><td>108</td><td>A</td></tr> <tr><td>05-140-83000</td><td>2557866</td><td>125</td><td>140</td><td>16</td><td>0,5</td><td>80</td><td>C</td></tr> <tr><td>05-160-83000</td><td>2557867</td><td>150</td><td>160</td><td>16</td><td>1,1</td><td>100</td><td>A</td></tr> <tr><td>05-180-83000</td><td>2557868</td><td>180</td><td>180</td><td>16</td><td>1,2</td><td>48</td><td>C</td></tr> <tr><td>05-200-83000</td><td>2557869</td><td>200</td><td>200</td><td>16</td><td>1,3</td><td>30</td><td>A</td></tr> <tr><td>05-225-83000</td><td>2557870</td><td>200</td><td>225</td><td>16</td><td>1,5</td><td>30</td><td>A</td></tr> <tr><td>05-250-83000</td><td>2557871</td><td>250</td><td>250</td><td>16</td><td>1,7</td><td>100</td><td>A</td></tr> <tr><td>05-280-83000</td><td>2557872</td><td>250</td><td>280</td><td>16</td><td>1,9</td><td>16</td><td>C</td></tr> <tr><td>05-315-83000</td><td>2557873</td><td>300</td><td>315</td><td>16</td><td>2,1</td><td>12</td><td>A</td></tr> </tbody> </table>	AVK nr.	RSK nr.	DN	Dd	PN	Vikt	St/pall	Kod	05-063-83000	2557861	50	63	16	0,2	432	B	05-075-83000	2557862	65	75	16	0,3	300	A	05-090-83000	2557863	80	90	16	0,3	208	A	05-110-83000	2557864	100	110	16	0,4	140	A	05-125-83000	2557865	125	125	16	0,4	108	A	05-140-83000	2557866	125	140	16	0,5	80	C	05-160-83000	2557867	150	160	16	1,1	100	A	05-180-83000	2557868	180	180	16	1,2	48	C	05-200-83000	2557869	200	200	16	1,3	30	A	05-225-83000	2557870	200	225	16	1,5	30	A	05-250-83000	2557871	250	250	16	1,7	100	A	05-280-83000	2557872	250	280	16	1,9	16	C	05-315-83000	2557873	300	315	16	2,1	12	A																																																																																
AVK nr.	RSK nr.	DN	Dd	PN	Vikt	St/pall	Kod																																																																																																																																																																																										
05-063-83000	2557861	50	63	16	0,2	432	B																																																																																																																																																																																										
05-075-83000	2557862	65	75	16	0,3	300	A																																																																																																																																																																																										
05-090-83000	2557863	80	90	16	0,3	208	A																																																																																																																																																																																										
05-110-83000	2557864	100	110	16	0,4	140	A																																																																																																																																																																																										
05-125-83000	2557865	125	125	16	0,4	108	A																																																																																																																																																																																										
05-140-83000	2557866	125	140	16	0,5	80	C																																																																																																																																																																																										
05-160-83000	2557867	150	160	16	1,1	100	A																																																																																																																																																																																										
05-180-83000	2557868	180	180	16	1,2	48	C																																																																																																																																																																																										
05-200-83000	2557869	200	200	16	1,3	30	A																																																																																																																																																																																										
05-225-83000	2557870	200	225	16	1,5	30	A																																																																																																																																																																																										
05-250-83000	2557871	250	250	16	1,7	100	A																																																																																																																																																																																										
05-280-83000	2557872	250	280	16	1,9	16	C																																																																																																																																																																																										
05-315-83000	2557873	300	315	16	2,1	12	A																																																																																																																																																																																										
<p>Serie 05/E-009 Stödhylsa för PE-rör PE 100, PN 10 63-400 mm SDR 11 Hel hylsa utan kil</p> 	<table border="1"> <thead> <tr> <th>AVK nr.</th> <th>RSK nr.</th> <th>DN</th> <th>Dd</th> <th>PN</th> <th>Vikt</th> <th>St/pall</th> <th>Kod</th> </tr> </thead> <tbody> <tr><td>05-063-84000</td><td>2557877</td><td>50</td><td>63</td><td>16</td><td>0,2</td><td>432</td><td>C</td></tr> <tr><td>05-075-84000</td><td>2557878</td><td>65</td><td>75</td><td>16</td><td>0,2</td><td>300</td><td>C</td></tr> <tr><td>05-090-84000</td><td>2557879</td><td>80</td><td>90</td><td>16</td><td>0,3</td><td>208</td><td>B</td></tr> <tr><td>05-110-84000</td><td>2557880</td><td>100</td><td>110</td><td>16</td><td>0,3</td><td>140</td><td>A</td></tr> <tr><td>05-125-84000</td><td>2557881</td><td>125</td><td>125</td><td>16</td><td>0,4</td><td>108</td><td>B</td></tr> <tr><td>05-140-84000</td><td>2557882</td><td>125</td><td>140</td><td>16</td><td>0,4</td><td>80</td><td>C</td></tr> <tr><td>05-160-84000</td><td>2557883</td><td>150</td><td>160</td><td>16</td><td>1</td><td>100</td><td>A</td></tr> <tr><td>05-180-84000</td><td>2557884</td><td>180</td><td>180</td><td>16</td><td>1,1</td><td>48</td><td>C</td></tr> <tr><td>05-200-84000</td><td>2557885</td><td>200</td><td>200</td><td>16</td><td>1,2</td><td>30</td><td>A</td></tr> <tr><td>05-225-84000</td><td>2557886</td><td>200</td><td>225</td><td>16</td><td>1,4</td><td>30</td><td>A</td></tr> <tr><td>05-250-84000</td><td>2557887</td><td>250</td><td>250</td><td>16</td><td>1,5</td><td>100</td><td>A</td></tr> <tr><td>05-280-84000</td><td>2557888</td><td>250</td><td>280</td><td>16</td><td>1,7</td><td>16</td><td>C</td></tr> <tr><td>05-315-84000</td><td>2557889</td><td>300</td><td>315</td><td>16</td><td>1,9</td><td>12</td><td>A</td></tr> </tbody> </table>	AVK nr.	RSK nr.	DN	Dd	PN	Vikt	St/pall	Kod	05-063-84000	2557877	50	63	16	0,2	432	C	05-075-84000	2557878	65	75	16	0,2	300	C	05-090-84000	2557879	80	90	16	0,3	208	B	05-110-84000	2557880	100	110	16	0,3	140	A	05-125-84000	2557881	125	125	16	0,4	108	B	05-140-84000	2557882	125	140	16	0,4	80	C	05-160-84000	2557883	150	160	16	1	100	A	05-180-84000	2557884	180	180	16	1,1	48	C	05-200-84000	2557885	200	200	16	1,2	30	A	05-225-84000	2557886	200	225	16	1,4	30	A	05-250-84000	2557887	250	250	16	1,5	100	A	05-280-84000	2557888	250	280	16	1,7	16	C	05-315-84000	2557889	300	315	16	1,9	12	A																																																																																
AVK nr.	RSK nr.	DN	Dd	PN	Vikt	St/pall	Kod																																																																																																																																																																																										
05-063-84000	2557877	50	63	16	0,2	432	C																																																																																																																																																																																										
05-075-84000	2557878	65	75	16	0,2	300	C																																																																																																																																																																																										
05-090-84000	2557879	80	90	16	0,3	208	B																																																																																																																																																																																										
05-110-84000	2557880	100	110	16	0,3	140	A																																																																																																																																																																																										
05-125-84000	2557881	125	125	16	0,4	108	B																																																																																																																																																																																										
05-140-84000	2557882	125	140	16	0,4	80	C																																																																																																																																																																																										
05-160-84000	2557883	150	160	16	1	100	A																																																																																																																																																																																										
05-180-84000	2557884	180	180	16	1,1	48	C																																																																																																																																																																																										
05-200-84000	2557885	200	200	16	1,2	30	A																																																																																																																																																																																										
05-225-84000	2557886	200	225	16	1,4	30	A																																																																																																																																																																																										
05-250-84000	2557887	250	250	16	1,5	100	A																																																																																																																																																																																										
05-280-84000	2557888	250	280	16	1,7	16	C																																																																																																																																																																																										
05-315-84000	2557889	300	315	16	1,9	12	A																																																																																																																																																																																										
<p>Serie 05/E-008 Stödhylsa för PE-rör PE 100, PN 10 PE 80, PN 6,3 63-400 mm SDR 17</p> 	<table border="1"> <thead> <tr> <th>AVK nr.</th> <th>RSK nr.</th> <th>DN</th> <th>PE-rör</th> <th>PN</th> <th>Vikt</th> <th>St/pall</th> <th>Kod</th> </tr> </thead> <tbody> <tr><td>05-063-53-000</td><td>1866682</td><td>50</td><td>63</td><td>10</td><td>0,4</td><td>432</td><td>A</td></tr> <tr><td>05-075-53-000</td><td>1866683</td><td>65</td><td>75</td><td>10</td><td>0,5</td><td>300</td><td>A</td></tr> <tr><td>05-090-53-000</td><td>1866684</td><td>80</td><td>90</td><td>10</td><td>0,7</td><td>250</td><td>A</td></tr> <tr><td>05-110-73-000</td><td>1866685</td><td>100</td><td>110</td><td>10</td><td>0,8</td><td>300</td><td>A</td></tr> <tr><td>05-125-73-000</td><td>1866686</td><td>125</td><td>125</td><td>10</td><td>1</td><td>108</td><td>A</td></tr> <tr><td>05-160-73-000</td><td>1866687</td><td>150</td><td>160</td><td>10</td><td>1,3</td><td>150</td><td>A</td></tr> <tr><td>05-180-73-000</td><td>1866707</td><td>180</td><td>180</td><td>10</td><td>1,4</td><td>48</td><td>A</td></tr> <tr><td>05-200-73-000</td><td>1866688</td><td>200</td><td>200</td><td>10</td><td>1,4</td><td>50</td><td>A</td></tr> <tr><td>05-225-73-000</td><td>1866689</td><td>200</td><td>225</td><td>10</td><td>1,9</td><td>75</td><td>A</td></tr> <tr><td>05-250-73-000</td><td>1866690</td><td>250</td><td>250</td><td>10</td><td>2,3</td><td>30</td><td>A</td></tr> <tr><td>05-280-73-000</td><td>1866691</td><td>250</td><td>280</td><td>10</td><td>2,7</td><td>25</td><td>A</td></tr> <tr><td>05-315-73-000</td><td>1866692</td><td>300</td><td>315</td><td>10</td><td>3,5</td><td>30</td><td>A</td></tr> <tr><td>05-355-73-000</td><td>1866710</td><td>350</td><td>355</td><td>10</td><td>4</td><td>20</td><td>A</td></tr> <tr><td>05-400-73-000</td><td>1866711</td><td>400</td><td>400</td><td>10</td><td>4,5</td><td>20</td><td>A</td></tr> <tr><td>05-450-73-000</td><td>2558066</td><td>450</td><td>450</td><td>10</td><td>4,9</td><td></td><td>A</td></tr> <tr><td>05-500-73-000</td><td>2558067</td><td>500</td><td>500</td><td>10</td><td>5,3</td><td></td><td>A</td></tr> <tr><td>05-560-73-000</td><td>2558068</td><td>560</td><td>560</td><td>10</td><td>5,5</td><td></td><td>A</td></tr> <tr><td>05-630-73-000</td><td>2558069</td><td>630</td><td>630</td><td>10</td><td>5,8</td><td></td><td>A</td></tr> </tbody> </table>	AVK nr.	RSK nr.	DN	PE-rör	PN	Vikt	St/pall	Kod	05-063-53-000	1866682	50	63	10	0,4	432	A	05-075-53-000	1866683	65	75	10	0,5	300	A	05-090-53-000	1866684	80	90	10	0,7	250	A	05-110-73-000	1866685	100	110	10	0,8	300	A	05-125-73-000	1866686	125	125	10	1	108	A	05-160-73-000	1866687	150	160	10	1,3	150	A	05-180-73-000	1866707	180	180	10	1,4	48	A	05-200-73-000	1866688	200	200	10	1,4	50	A	05-225-73-000	1866689	200	225	10	1,9	75	A	05-250-73-000	1866690	250	250	10	2,3	30	A	05-280-73-000	1866691	250	280	10	2,7	25	A	05-315-73-000	1866692	300	315	10	3,5	30	A	05-355-73-000	1866710	350	355	10	4	20	A	05-400-73-000	1866711	400	400	10	4,5	20	A	05-450-73-000	2558066	450	450	10	4,9		A	05-500-73-000	2558067	500	500	10	5,3		A	05-560-73-000	2558068	560	560	10	5,5		A	05-630-73-000	2558069	630	630	10	5,8		A																																								
AVK nr.	RSK nr.	DN	PE-rör	PN	Vikt	St/pall	Kod																																																																																																																																																																																										
05-063-53-000	1866682	50	63	10	0,4	432	A																																																																																																																																																																																										
05-075-53-000	1866683	65	75	10	0,5	300	A																																																																																																																																																																																										
05-090-53-000	1866684	80	90	10	0,7	250	A																																																																																																																																																																																										
05-110-73-000	1866685	100	110	10	0,8	300	A																																																																																																																																																																																										
05-125-73-000	1866686	125	125	10	1	108	A																																																																																																																																																																																										
05-160-73-000	1866687	150	160	10	1,3	150	A																																																																																																																																																																																										
05-180-73-000	1866707	180	180	10	1,4	48	A																																																																																																																																																																																										
05-200-73-000	1866688	200	200	10	1,4	50	A																																																																																																																																																																																										
05-225-73-000	1866689	200	225	10	1,9	75	A																																																																																																																																																																																										
05-250-73-000	1866690	250	250	10	2,3	30	A																																																																																																																																																																																										
05-280-73-000	1866691	250	280	10	2,7	25	A																																																																																																																																																																																										
05-315-73-000	1866692	300	315	10	3,5	30	A																																																																																																																																																																																										
05-355-73-000	1866710	350	355	10	4	20	A																																																																																																																																																																																										
05-400-73-000	1866711	400	400	10	4,5	20	A																																																																																																																																																																																										
05-450-73-000	2558066	450	450	10	4,9		A																																																																																																																																																																																										
05-500-73-000	2558067	500	500	10	5,3		A																																																																																																																																																																																										
05-560-73-000	2558068	560	560	10	5,5		A																																																																																																																																																																																										
05-630-73-000	2558069	630	630	10	5,8		A																																																																																																																																																																																										
<p>Serie 05/E-008 Stödhylsa för PE-rör PE 80, PN 10 PE 100, PN 16 PE 80, PN 12,5 32-400 mm SDR 11</p> <p>(1) Tillverkade av plast med inbyggd fasning.</p> 	<table border="1"> <thead> <tr> <th>AVK nr.</th> <th>RSK nr.</th> <th>DN</th> <th>PE-rör</th> <th>PN</th> <th>Vikt</th> <th>St/pall</th> <th>Kod</th> </tr> </thead> <tbody> <tr><td>1832 (1)</td><td>2434596</td><td>25</td><td>32</td><td>16</td><td>0,1</td><td></td><td>A</td></tr> <tr><td>8009 (1)</td><td>2434597</td><td>32</td><td>40</td><td>16</td><td>0,2</td><td></td><td>A</td></tr> <tr><td>4230 (1)</td><td>2434598</td><td>40</td><td>50</td><td>16</td><td>0,3</td><td></td><td>A</td></tr> <tr><td>4217 (1)</td><td>2434599</td><td>50</td><td>63</td><td>16</td><td>0,4</td><td></td><td>A</td></tr> <tr><td>05-063-54-000</td><td>1866694</td><td>50</td><td>63</td><td>16</td><td>0,4</td><td>432</td><td>A</td></tr> <tr><td>05-075-54-000</td><td>1866695</td><td>65</td><td>75</td><td>16</td><td>0,5</td><td>300</td><td>A</td></tr> <tr><td>05-090-54-000</td><td>1866696</td><td>80</td><td>90</td><td>16</td><td>0,7</td><td>208</td><td>A</td></tr> <tr><td>05-110-74-000</td><td>1866697</td><td>100</td><td>110</td><td>16</td><td>0,8</td><td>150</td><td>A</td></tr> <tr><td>05-125-74-000</td><td>1866698</td><td>125</td><td>125</td><td>16</td><td>1</td><td>108</td><td>A</td></tr> <tr><td>05-140-74-000</td><td>1866699</td><td>125</td><td>140</td><td>16</td><td>1,1</td><td>80</td><td>A</td></tr> <tr><td>05-160-74-000</td><td>1866700</td><td>150</td><td>160</td><td>16</td><td>1,3</td><td>100</td><td>A</td></tr> <tr><td>05-180-74-000</td><td>1866701</td><td>180</td><td>180</td><td>16</td><td>1,4</td><td>48</td><td>A</td></tr> <tr><td>05-200-74-000</td><td>1866702</td><td>200</td><td>200</td><td>16</td><td>1,4</td><td>40</td><td>A</td></tr> <tr><td>05-225-74-000</td><td>1866703</td><td>200</td><td>225</td><td>16</td><td>2</td><td>50</td><td>A</td></tr> <tr><td>05-250-74-000</td><td>1866704</td><td>250</td><td>250</td><td>16</td><td>2,5</td><td>100</td><td>A</td></tr> <tr><td>05-280-74-000</td><td>1866705</td><td>250</td><td>280</td><td>16</td><td>3,3</td><td>30</td><td>A</td></tr> <tr><td>05-315-74-000</td><td>1866706</td><td>300</td><td>315</td><td>16</td><td>3,3</td><td>50</td><td>A</td></tr> <tr><td>05-355-74-000</td><td>1866712</td><td>350</td><td>355</td><td>16</td><td>3,8</td><td>30</td><td>A</td></tr> <tr><td>05-400-74-000</td><td>1866713</td><td>400</td><td>400</td><td>16</td><td>4,3</td><td>30</td><td>A</td></tr> <tr><td>05-450-74-000</td><td>2558070</td><td>450</td><td>450</td><td>16</td><td>4,9</td><td></td><td>A</td></tr> <tr><td>05-500-74-000</td><td>2558071</td><td>500</td><td>500</td><td>16</td><td>5,3</td><td></td><td>A</td></tr> <tr><td>05-560-74-000</td><td>2558072</td><td>560</td><td>560</td><td>16</td><td>5,5</td><td></td><td>A</td></tr> <tr><td>05-630-74-000</td><td>2558070</td><td>630</td><td>630</td><td>16</td><td>5,8</td><td></td><td>A</td></tr> </tbody> </table>	AVK nr.	RSK nr.	DN	PE-rör	PN	Vikt	St/pall	Kod	1832 (1)	2434596	25	32	16	0,1		A	8009 (1)	2434597	32	40	16	0,2		A	4230 (1)	2434598	40	50	16	0,3		A	4217 (1)	2434599	50	63	16	0,4		A	05-063-54-000	1866694	50	63	16	0,4	432	A	05-075-54-000	1866695	65	75	16	0,5	300	A	05-090-54-000	1866696	80	90	16	0,7	208	A	05-110-74-000	1866697	100	110	16	0,8	150	A	05-125-74-000	1866698	125	125	16	1	108	A	05-140-74-000	1866699	125	140	16	1,1	80	A	05-160-74-000	1866700	150	160	16	1,3	100	A	05-180-74-000	1866701	180	180	16	1,4	48	A	05-200-74-000	1866702	200	200	16	1,4	40	A	05-225-74-000	1866703	200	225	16	2	50	A	05-250-74-000	1866704	250	250	16	2,5	100	A	05-280-74-000	1866705	250	280	16	3,3	30	A	05-315-74-000	1866706	300	315	16	3,3	50	A	05-355-74-000	1866712	350	355	16	3,8	30	A	05-400-74-000	1866713	400	400	16	4,3	30	A	05-450-74-000	2558070	450	450	16	4,9		A	05-500-74-000	2558071	500	500	16	5,3		A	05-560-74-000	2558072	560	560	16	5,5		A	05-630-74-000	2558070	630	630	16	5,8		A
AVK nr.	RSK nr.	DN	PE-rör	PN	Vikt	St/pall	Kod																																																																																																																																																																																										
1832 (1)	2434596	25	32	16	0,1		A																																																																																																																																																																																										
8009 (1)	2434597	32	40	16	0,2		A																																																																																																																																																																																										
4230 (1)	2434598	40	50	16	0,3		A																																																																																																																																																																																										
4217 (1)	2434599	50	63	16	0,4		A																																																																																																																																																																																										
05-063-54-000	1866694	50	63	16	0,4	432	A																																																																																																																																																																																										
05-075-54-000	1866695	65	75	16	0,5	300	A																																																																																																																																																																																										
05-090-54-000	1866696	80	90	16	0,7	208	A																																																																																																																																																																																										
05-110-74-000	1866697	100	110	16	0,8	150	A																																																																																																																																																																																										
05-125-74-000	1866698	125	125	16	1	108	A																																																																																																																																																																																										
05-140-74-000	1866699	125	140	16	1,1	80	A																																																																																																																																																																																										
05-160-74-000	1866700	150	160	16	1,3	100	A																																																																																																																																																																																										
05-180-74-000	1866701	180	180	16	1,4	48	A																																																																																																																																																																																										
05-200-74-000	1866702	200	200	16	1,4	40	A																																																																																																																																																																																										
05-225-74-000	1866703	200	225	16	2	50	A																																																																																																																																																																																										
05-250-74-000	1866704	250	250	16	2,5	100	A																																																																																																																																																																																										
05-280-74-000	1866705	250	280	16	3,3	30	A																																																																																																																																																																																										
05-315-74-000	1866706	300	315	16	3,3	50	A																																																																																																																																																																																										
05-355-74-000	1866712	350	355	16	3,8	30	A																																																																																																																																																																																										
05-400-74-000	1866713	400	400	16	4,3	30	A																																																																																																																																																																																										
05-450-74-000	2558070	450	450	16	4,9		A																																																																																																																																																																																										
05-500-74-000	2558071	500	500	16	5,3		A																																																																																																																																																																																										
05-560-74-000	2558072	560	560	16	5,5		A																																																																																																																																																																																										
05-630-74-000	2558070	630	630	16	5,8		A																																																																																																																																																																																										

<p>Serie 05/26-003 Kombiflans för segjärn Dragfast packningsring Komplett med bultar Avvinkling max ±3,5° DN 50-300 EPDM gummi</p> 	<table border="1"> <thead> <tr> <th>AVK nr.</th> <th>RSK nr.</th> <th>DN</th> <th>Dd</th> <th>PN</th> <th>Vikt</th> <th>St/pall</th> <th>Kod</th> </tr> </thead> <tbody> <tr><td>05-118-26-1002100</td><td>1093708</td><td>100</td><td>118</td><td>10/16</td><td>8</td><td>22</td><td>C</td></tr> <tr><td>05-170-26-1502100</td><td>1093709</td><td>150</td><td>170</td><td>10/16</td><td>9,2</td><td>25</td><td>C</td></tr> <tr><td>05-222-26-2002400</td><td>1093710</td><td>200</td><td>222</td><td>10</td><td>13</td><td>12</td><td>C</td></tr> <tr><td>05-222-26-2004400</td><td>1093711</td><td>200</td><td>222</td><td>16</td><td>14</td><td>3</td><td>C</td></tr> <tr><td>05-274-26-2502400</td><td>1093712</td><td>250</td><td>274</td><td>10</td><td>27</td><td>10</td><td>C</td></tr> <tr><td>05-274-26-2504400</td><td>1093713</td><td>250</td><td>274</td><td>16</td><td>27</td><td>2</td><td>C</td></tr> <tr><td>05-326-26-3002400</td><td>1093714</td><td>300</td><td>326</td><td>10</td><td>31</td><td>8</td><td>C</td></tr> <tr><td>05-326-26-3004400</td><td>1093716</td><td>300</td><td>326</td><td>16</td><td>30</td><td>2</td><td>C</td></tr> </tbody> </table>	AVK nr.	RSK nr.	DN	Dd	PN	Vikt	St/pall	Kod	05-118-26-1002100	1093708	100	118	10/16	8	22	C	05-170-26-1502100	1093709	150	170	10/16	9,2	25	C	05-222-26-2002400	1093710	200	222	10	13	12	C	05-222-26-2004400	1093711	200	222	16	14	3	C	05-274-26-2502400	1093712	250	274	10	27	10	C	05-274-26-2504400	1093713	250	274	16	27	2	C	05-326-26-3002400	1093714	300	326	10	31	8	C	05-326-26-3004400	1093716	300	326	16	30	2	C																																																																								
AVK nr.	RSK nr.	DN	Dd	PN	Vikt	St/pall	Kod																																																																																																																																										
05-118-26-1002100	1093708	100	118	10/16	8	22	C																																																																																																																																										
05-170-26-1502100	1093709	150	170	10/16	9,2	25	C																																																																																																																																										
05-222-26-2002400	1093710	200	222	10	13	12	C																																																																																																																																										
05-222-26-2004400	1093711	200	222	16	14	3	C																																																																																																																																										
05-274-26-2502400	1093712	250	274	10	27	10	C																																																																																																																																										
05-274-26-2504400	1093713	250	274	16	27	2	C																																																																																																																																										
05-326-26-3002400	1093714	300	326	10	31	8	C																																																																																																																																										
05-326-26-3004400	1093716	300	326	16	30	2	C																																																																																																																																										
<p>Serie 05/66-004 Kombiflans för segjärn Ej dragfast standardpackningsring Komplett med bultar Avvinkling max ±3,5° DN 50-300 EPDM gummi</p> 	<table border="1"> <thead> <tr> <th>AVK nr.</th> <th>RSK nr.</th> <th>DN</th> <th>Dd</th> <th>PN</th> <th>Vikt</th> <th>St/pall</th> <th>Kod</th> </tr> </thead> <tbody> <tr><td>05-100-66-1002100</td><td>1093717</td><td>100</td><td>118</td><td>10/16</td><td>7,8</td><td>11</td><td>C</td></tr> <tr><td>05-150-66-1502100</td><td>1093718</td><td>150</td><td>170</td><td>10/16</td><td>9</td><td>12</td><td>C</td></tr> <tr><td>05-200-66-2002400</td><td>1093719</td><td>200</td><td>222</td><td>10</td><td>12</td><td>12</td><td>C</td></tr> <tr><td>05-200-66-2004400</td><td>1093720</td><td>200</td><td>222</td><td>16</td><td>13,5</td><td>6</td><td>C</td></tr> <tr><td>05-250-66-2502400</td><td>1093721</td><td>250</td><td>274</td><td>10</td><td>25</td><td>6</td><td>C</td></tr> <tr><td>05-250-66-2504400</td><td>1093722</td><td>250</td><td>274</td><td>16</td><td>25</td><td>6</td><td>C</td></tr> <tr><td>05-300-66-3002400</td><td>1093724</td><td>300</td><td>326</td><td>10</td><td>29</td><td>2</td><td>C</td></tr> <tr><td>05-300-66-3004400</td><td>1093725</td><td>300</td><td>326</td><td>16</td><td>28</td><td>2</td><td>C</td></tr> </tbody> </table>	AVK nr.	RSK nr.	DN	Dd	PN	Vikt	St/pall	Kod	05-100-66-1002100	1093717	100	118	10/16	7,8	11	C	05-150-66-1502100	1093718	150	170	10/16	9	12	C	05-200-66-2002400	1093719	200	222	10	12	12	C	05-200-66-2004400	1093720	200	222	16	13,5	6	C	05-250-66-2502400	1093721	250	274	10	25	6	C	05-250-66-2504400	1093722	250	274	16	25	6	C	05-300-66-3002400	1093724	300	326	10	29	2	C	05-300-66-3004400	1093725	300	326	16	28	2	C																																																																								
AVK nr.	RSK nr.	DN	Dd	PN	Vikt	St/pall	Kod																																																																																																																																										
05-100-66-1002100	1093717	100	118	10/16	7,8	11	C																																																																																																																																										
05-150-66-1502100	1093718	150	170	10/16	9	12	C																																																																																																																																										
05-200-66-2002400	1093719	200	222	10	12	12	C																																																																																																																																										
05-200-66-2004400	1093720	200	222	16	13,5	6	C																																																																																																																																										
05-250-66-2502400	1093721	250	274	10	25	6	C																																																																																																																																										
05-250-66-2504400	1093722	250	274	16	25	6	C																																																																																																																																										
05-300-66-3002400	1093724	300	326	10	29	2	C																																																																																																																																										
05-300-66-3004400	1093725	300	326	16	28	2	C																																																																																																																																										
<p>Serie 05/60-002 Kombiflans för PVC-PE-rör Dragfast packningsring Komplett med bultar PN 10: Avvinkling max ±3,5° PN 16: Avvinkling max ±1,5° Stödhylsor bör användas Dn 50-300 EPDM gummi</p> 	<table border="1"> <thead> <tr> <th>AVK nr.</th> <th>RSK nr.</th> <th>DN</th> <th>Dd</th> <th>PN</th> <th>Vikt</th> <th>St/pall</th> <th>Kod</th> </tr> </thead> <tbody> <tr><td>05-050-16-0638203</td><td>1093726</td><td>50</td><td>63</td><td>10/16</td><td>2,8</td><td>88</td><td>C</td></tr> <tr><td>05-075-16-0758203</td><td>1093727</td><td>65</td><td>75</td><td>10/16</td><td>3</td><td>88</td><td>C</td></tr> <tr><td>05-090-16-0908203</td><td>1093728</td><td>80</td><td>90</td><td>10/16</td><td>4,1</td><td>33</td><td>C</td></tr> <tr><td>05-110-16-1108203</td><td>1093729</td><td>100</td><td>110</td><td>10/16</td><td>4,6</td><td>33</td><td>C</td></tr> <tr><td>05-125-16-1258203</td><td>1093730</td><td>125</td><td>125</td><td>10/16</td><td>5,2</td><td>88</td><td>C</td></tr> <tr><td>05-140-16-1408203</td><td>1093732</td><td>125</td><td>140</td><td>10/16</td><td>6,2</td><td>1</td><td>C</td></tr> <tr><td>05-160-16-1608203</td><td>1093733</td><td>150</td><td>160</td><td>10/16</td><td>7,7</td><td>14</td><td>C</td></tr> <tr><td>05-200-16-2008303</td><td>1093734</td><td>200</td><td>200</td><td>10</td><td>9,4</td><td>11</td><td>C</td></tr> <tr><td>05-200-16-2008203</td><td>1093735</td><td>200</td><td>200</td><td>16</td><td>9,4</td><td>10</td><td>C</td></tr> <tr><td>05-225-16-2258303</td><td>1093736</td><td>200</td><td>225</td><td>10</td><td>10</td><td>11</td><td>C</td></tr> <tr><td>05-225-16-2258203</td><td>1093737</td><td>200</td><td>225</td><td>16</td><td>10</td><td>11</td><td>C</td></tr> <tr><td>05-250-16-2508303</td><td>1093738</td><td>250</td><td>250</td><td>10</td><td>14</td><td>7</td><td>C</td></tr> <tr><td>05-250-16-2508203</td><td>1093739</td><td>250</td><td>250</td><td>16</td><td>14</td><td>7</td><td>C</td></tr> <tr><td>05-280-16-2808303</td><td>1093740</td><td>250</td><td>280</td><td>10</td><td>14</td><td>7</td><td>C</td></tr> <tr><td>05-280-16-2808203</td><td>1093741</td><td>250</td><td>280</td><td>16</td><td>14</td><td>6</td><td>C</td></tr> <tr><td>05-315-16-3158303</td><td>1093742</td><td>300</td><td>315</td><td>10</td><td>16</td><td>10</td><td>C</td></tr> <tr><td>05-315-16-3158203</td><td>1093743</td><td>300</td><td>315</td><td>16</td><td>16</td><td>4</td><td>C</td></tr> </tbody> </table>	AVK nr.	RSK nr.	DN	Dd	PN	Vikt	St/pall	Kod	05-050-16-0638203	1093726	50	63	10/16	2,8	88	C	05-075-16-0758203	1093727	65	75	10/16	3	88	C	05-090-16-0908203	1093728	80	90	10/16	4,1	33	C	05-110-16-1108203	1093729	100	110	10/16	4,6	33	C	05-125-16-1258203	1093730	125	125	10/16	5,2	88	C	05-140-16-1408203	1093732	125	140	10/16	6,2	1	C	05-160-16-1608203	1093733	150	160	10/16	7,7	14	C	05-200-16-2008303	1093734	200	200	10	9,4	11	C	05-200-16-2008203	1093735	200	200	16	9,4	10	C	05-225-16-2258303	1093736	200	225	10	10	11	C	05-225-16-2258203	1093737	200	225	16	10	11	C	05-250-16-2508303	1093738	250	250	10	14	7	C	05-250-16-2508203	1093739	250	250	16	14	7	C	05-280-16-2808303	1093740	250	280	10	14	7	C	05-280-16-2808203	1093741	250	280	16	14	6	C	05-315-16-3158303	1093742	300	315	10	16	10	C	05-315-16-3158203	1093743	300	315	16	16	4	C
AVK nr.	RSK nr.	DN	Dd	PN	Vikt	St/pall	Kod																																																																																																																																										
05-050-16-0638203	1093726	50	63	10/16	2,8	88	C																																																																																																																																										
05-075-16-0758203	1093727	65	75	10/16	3	88	C																																																																																																																																										
05-090-16-0908203	1093728	80	90	10/16	4,1	33	C																																																																																																																																										
05-110-16-1108203	1093729	100	110	10/16	4,6	33	C																																																																																																																																										
05-125-16-1258203	1093730	125	125	10/16	5,2	88	C																																																																																																																																										
05-140-16-1408203	1093732	125	140	10/16	6,2	1	C																																																																																																																																										
05-160-16-1608203	1093733	150	160	10/16	7,7	14	C																																																																																																																																										
05-200-16-2008303	1093734	200	200	10	9,4	11	C																																																																																																																																										
05-200-16-2008203	1093735	200	200	16	9,4	10	C																																																																																																																																										
05-225-16-2258303	1093736	200	225	10	10	11	C																																																																																																																																										
05-225-16-2258203	1093737	200	225	16	10	11	C																																																																																																																																										
05-250-16-2508303	1093738	250	250	10	14	7	C																																																																																																																																										
05-250-16-2508203	1093739	250	250	16	14	7	C																																																																																																																																										
05-280-16-2808303	1093740	250	280	10	14	7	C																																																																																																																																										
05-280-16-2808203	1093741	250	280	16	14	6	C																																																																																																																																										
05-315-16-3158303	1093742	300	315	10	16	10	C																																																																																																																																										
05-315-16-3158203	1093743	300	315	16	16	4	C																																																																																																																																										
<p>Serie 05/62-002 Kombiflans för PVC- och PE-rör Ej dragfast packningsring Komplett med bultar PN 10: Avvinkling max ±3,5° PN 16: Avvinkling max ±1,5° Stödhylsor bör användas Dn 50-300 EPDM gummi</p> 	<table border="1"> <thead> <tr> <th>AVK nr.</th> <th>RSK nr.</th> <th>DN</th> <th>Dd</th> <th>PN</th> <th>Vikt</th> <th>St/pall</th> <th>Kod</th> </tr> </thead> <tbody> <tr><td>05-050-76-0638203</td><td>1093744</td><td>50</td><td>63</td><td>10/16</td><td>2,6</td><td>147</td><td>C</td></tr> <tr><td>05-075-76-0758203</td><td>1093745</td><td>65</td><td>75</td><td>10/16</td><td>2,7</td><td>88</td><td>C</td></tr> <tr><td>05-090-76-0908203</td><td>1093746</td><td>80</td><td>90</td><td>10/16</td><td>3,6</td><td>33</td><td>C</td></tr> <tr><td>05-110-76-1108203</td><td>1093747</td><td>100</td><td>110</td><td>10/16</td><td>4,3</td><td>33</td><td>C</td></tr> <tr><td>05-125-76-1258203</td><td>1093748</td><td>125</td><td>125</td><td>10/16</td><td>5,6</td><td>88</td><td>C</td></tr> <tr><td>05-140-76-1408203</td><td>1093750</td><td>125</td><td>140</td><td>10/16</td><td>5,6</td><td>7</td><td>C</td></tr> <tr><td>05-160-76-1608203</td><td>1093751</td><td>150</td><td>160</td><td>10/16</td><td>7,3</td><td>14</td><td>C</td></tr> <tr><td>05-200-76-2008303</td><td>1093752</td><td>200</td><td>200</td><td>10</td><td>9,2</td><td>11</td><td>C</td></tr> <tr><td>05-200-76-2008203</td><td>1093753</td><td>200</td><td>200</td><td>16</td><td>9,2</td><td>24</td><td>C</td></tr> <tr><td>05-225-76-2258303</td><td>1093754</td><td>200</td><td>225</td><td>10</td><td>9,4</td><td>11</td><td>C</td></tr> <tr><td>05-225-76-2258203</td><td>1093755</td><td>200</td><td>225</td><td>16</td><td>9,4</td><td>5</td><td>C</td></tr> <tr><td>05-250-76-2508303</td><td>1093757</td><td>250</td><td>250</td><td>10</td><td>13</td><td>7</td><td>C</td></tr> <tr><td>05-250-76-2508203</td><td>1093758</td><td>250</td><td>250</td><td>16</td><td>13</td><td>8</td><td>C</td></tr> <tr><td>05-280-76-2808303</td><td>1093759</td><td>250</td><td>280</td><td>10</td><td>13</td><td>7</td><td>C</td></tr> <tr><td>05-280-76-2808203</td><td>1093760</td><td>250</td><td>280</td><td>16</td><td>13</td><td>6</td><td>C</td></tr> <tr><td>05-315-76-3158303</td><td>1093761</td><td>300</td><td>315</td><td>10</td><td>15</td><td>6</td><td>C</td></tr> <tr><td>05-315-76-3158203</td><td>1093762</td><td>300</td><td>315</td><td>16</td><td>15</td><td>4</td><td>C</td></tr> </tbody> </table>	AVK nr.	RSK nr.	DN	Dd	PN	Vikt	St/pall	Kod	05-050-76-0638203	1093744	50	63	10/16	2,6	147	C	05-075-76-0758203	1093745	65	75	10/16	2,7	88	C	05-090-76-0908203	1093746	80	90	10/16	3,6	33	C	05-110-76-1108203	1093747	100	110	10/16	4,3	33	C	05-125-76-1258203	1093748	125	125	10/16	5,6	88	C	05-140-76-1408203	1093750	125	140	10/16	5,6	7	C	05-160-76-1608203	1093751	150	160	10/16	7,3	14	C	05-200-76-2008303	1093752	200	200	10	9,2	11	C	05-200-76-2008203	1093753	200	200	16	9,2	24	C	05-225-76-2258303	1093754	200	225	10	9,4	11	C	05-225-76-2258203	1093755	200	225	16	9,4	5	C	05-250-76-2508303	1093757	250	250	10	13	7	C	05-250-76-2508203	1093758	250	250	16	13	8	C	05-280-76-2808303	1093759	250	280	10	13	7	C	05-280-76-2808203	1093760	250	280	16	13	6	C	05-315-76-3158303	1093761	300	315	10	15	6	C	05-315-76-3158203	1093762	300	315	16	15	4	C
AVK nr.	RSK nr.	DN	Dd	PN	Vikt	St/pall	Kod																																																																																																																																										
05-050-76-0638203	1093744	50	63	10/16	2,6	147	C																																																																																																																																										
05-075-76-0758203	1093745	65	75	10/16	2,7	88	C																																																																																																																																										
05-090-76-0908203	1093746	80	90	10/16	3,6	33	C																																																																																																																																										
05-110-76-1108203	1093747	100	110	10/16	4,3	33	C																																																																																																																																										
05-125-76-1258203	1093748	125	125	10/16	5,6	88	C																																																																																																																																										
05-140-76-1408203	1093750	125	140	10/16	5,6	7	C																																																																																																																																										
05-160-76-1608203	1093751	150	160	10/16	7,3	14	C																																																																																																																																										
05-200-76-2008303	1093752	200	200	10	9,2	11	C																																																																																																																																										
05-200-76-2008203	1093753	200	200	16	9,2	24	C																																																																																																																																										
05-225-76-2258303	1093754	200	225	10	9,4	11	C																																																																																																																																										
05-225-76-2258203	1093755	200	225	16	9,4	5	C																																																																																																																																										
05-250-76-2508303	1093757	250	250	10	13	7	C																																																																																																																																										
05-250-76-2508203	1093758	250	250	16	13	8	C																																																																																																																																										
05-280-76-2808303	1093759	250	280	10	13	7	C																																																																																																																																										
05-280-76-2808203	1093760	250	280	16	13	6	C																																																																																																																																										
05-315-76-3158303	1093761	300	315	10	15	6	C																																																																																																																																										
05-315-76-3158203	1093762	300	315	16	15	4	C																																																																																																																																										

Serie 621/10-001

AVK Supa Plus™ koppling med dragfast packningsring för PE- och uPVC-rör
Epoxibelagd in- och utvändigt
Min GGG-40
DN 32-300
Rostfritt stål, skruv A2/mutter A4, grad 80 Muttern PTFE-belagd
DN 40-300



AVK nr.	RSK nr.	DN	uPVC/PE ø mm	PN	Vikt	St/pall	Kod
621-10-040-41001	1140340	32	40	16	2,5	6	C
621-10-050-41001	1140341	40	50	16	2,8	6	C
621-10-063-41001	1140342	50	63	16	3,5	6	C
621-10-075-41001	1140343	65	75	16	5,7	24	C
621-10-090-41001	1140344	80	90	16	4,7	72	C
621-10-110-41001	1140345	100	110	16	6,5	66	C
621-10-125-41001	1140346	125	125	16	8	72	C
621-10-140-41001	1140347	125	140	16	11	6	C
621-10-160-41001	1140348	150	160	16	9,8	42	C
621-10-180-41001	1140349	150	180	16	9,8	6	C
621-10-200-41001	1140350	200	200	16	14	6	C
621-10-225-41001	1140351	200	225	16	20	6	C
621-10-250-41001	1140352	250	250	16	27	6	C
621-10-280-41001	1140353	250	280	16	30	6	C
621-10-315-41001	1140354	300	315	16	45	6	C

Serie 623/10-004

AVK Supa Plus™ flänsadapter med dragfast packningsring för PE- och uPVC-rör
Epoxibelagd in- och utvändigt
Min GGG-40
DN 40-300
Rostfritt stål, skruv A2/mutter A4, grad 80 Muttern PTFE-belagd
DN 40-300



* 10/16 universalborring

AVK nr.	RSK nr.	DN	uPVC/PE ø mm	PN	Vikt	St/pall	Kod
623-10-040-6141001	1140355	40	40	10/16	6,3	70	C
623-10-050-6141001	1140356	40	50	10/16	3,7	55	C
623-10-063-6141001	1140357	50	63	10/16	4,4	54	C
623-10-075-6141001	1140358	65	75	10/16	4,5	35	C
623-10-090-6141001	1140359	80	90	10/16	4,7	30	C
623-10-110-6141001	1140360	100	110	10/16	6,6	24	B
623-10-125-6141001	1140361	125	125	10/16	6,8	15	C
623-10-140-6141001	1140362	125	140	10/16	6,9	15	C
623-10-160-6141001	1140363	150	160	10/16	8,3	15	C
623-10-180-6141001	1140364	150	180	10/16	10	25	C
623-10-200-6041001	1140365	200	200	10	14	7	C
623-10-200-6141001	1140495	200	200	16	14	7	C
623-10-225-6041001	1140366	200	225	10	15	7	C
623-10-225-6141001	1140496	200	225	16	15	7	C
623-10-250-6241001	1140509	200	250	10/16	25	5	C
623-10-250-6141001	1140367	250	250	10/16	25	5	C
623-10-280-6141001	1140368	250	280	10/16	25	4	C
623-10-315-6241001	1140593	250	315	10/16	29	9	C
623-10-315-6141001	1140369	300	315	10/16	29	3	C

Serie 624/10-001

AVK Supa Plus™ Dragfast huv för PE- och PVC-rör
EPDM packning
Epoxi målad
Mutter A2
Mutter A4
DN 32-300



Anm

* 1 1/4" BSP invändig gänga

** 2" BSP invändig gänga

AVK nr.	RSK nr.	DN	PN	Vikt	Kod
624-10-040-6100041 *	1141728	32	16	3,8	C
624-10-050-6100041 *	1141729	40	16	4,2	C
624-10-063-6100041 *	1141730	50	16	4,3	C
624-10-063-6100061 **	1141731	50	16	4,3	C
624-10-075-6100041 *	1141732	65	16	4,6	C
624-10-075-6100061 **	1141733	65	16	4,6	C
624-10-090-6100041 *	1141734	80	16	5	C
624-10-090-6100061 **	1141735	80	16	5	C
624-10-110-6100041 *	1141736	100	16	6,5	C
624-10-110-6100061 **	1141737	100	16	6,5	C
624-10-125-6100041 *	1141738	125	16	7,6	C
624-10-125-6100061 **	1141739	125	16	7,6	C
624-10-140-6100041 *	1141740	125	16	8,4	C
624-10-140-6100061 **	1141741	125	16	8,4	C
624-10-160-6100041 *	1141742	150	16	9,8	C
624-10-160-6100061 **	1141743	150	16	9,8	C
624-10-180-6100041 *	1141744	150	16	13	C
624-10-180-6100061 **	1141745	150	16	13	C
624-10-200-6100041 *	1141746	200	16	14	C
624-10-200-6100061 **	1141747	200	16	14	C
624-10-225-6100041 *	1141748	200	16	19	C
624-10-225-6100061 **	1141749	200	16	19	C
624-10-250-6100041 *	1141750	250	16	26	C
624-10-250-6100061 **	1141751	250	16	26	C
624-10-280-6100041 *	1141752	250	16	30	C
624-10-280-6100061 **	1141753	250	16	30	C
624-10-315-6100041 *	1141754	300	16	32	C
624-10-315-6100061 **	1141755	300	16	32	C

Serie 601/A-011

Universal AVK Flexkoppling
För rör i gråjärn, segjärn, stål,
PVC och asbestcement
Upp till PN 16
Segjärn
Epoxibeläggning in- och
utvändigt
Rostfritt stål, skruv A2/
mutter A4, grad 80
PTFE-belagd mutter
DN 40-400



AVK nr.	RSK nr.	DN	T mm	PN	Vikt	St/pall	Kod
601-063-000-6400	1141394	40	46-63	16	2,9	54	C
601-074-000-6400	1141395	50	57-74	16	4,2	54	C
601-085-000-6400	1141396	65	68-85	16	3,9	40	C
601-106-000-6400	1141397	80	84-106	16	4,9	28	C
601-119-000-6400	1141398	100	99-119	16	5,2	24	C
601-133-000-6400	1141399	100	109-133	16	5,5	24	C
601-157-000-6400	1141400	125	132-157	16	6,5	30	C
601-183-000-6400	1141401	150	157-183	16	7,5	24	C
601-201-000-6400	1141402	150	176-201	16	12	12	C
601-215-000-6400	1141403	200	193-215	16	9,4	25	C
601-242-000-6400	1141404	200	218-242	16	15	8	C
601-268-000-6400	1141405	225	242-268	16	13	6	C
601-292-000-6400	1141406	250	266-292	16	21	6	C
601-306-000-6400	1141407	250	280-306	16	23	6	C
601-327-000-6400	1141408	300	301-327	16	16	5	C
601-350-000-6400	1141409	300	324-350	16	17	9	C
601-378-000-6400	1141410	350	352-378	16	20	2	C
601-396-000-6400	1141411	350	372-396	16	28	2	C
601-410-000-6400	1141412	350	384-410	16	22	2	C
601-436-000-6400	1141413	400	410-436	16	29	6	C
601-462-000-6400	1141414	400	436-462	16	32	2	C

Serie 602/4-001

Universal AVK Flexkoppling,
reducerad
För rör i gråjärn, segjärn, stål,
PVC och asbestcement
Upp till PN 16
Epoxibeläggning
in- och utvändigt
Segjärn
Rostfritt stål, skruv A2/mutter
A4, grad 80
PTFE-belagd mutter
DN 40-400



AVK nr.	RSK nr.	Rör		T1 mm	T2 mm	PN	Vikt	St/pall	Kod
		DN1/DN2	T1 mm						
602-063-074-6400	1141415	40/50	46-63	57-74	16	3,2	54	C	
602-063-085-6400	1141416	40/65	46-63	68-85	16	4,2	40	C	
602-074-085-6400	1141417	50/65	57-74	68-85	16	4,5	40	C	
602-074-106-6400	1141418	50/80	57-74	84-106	16	4,5	28	C	
602-085-106-6400	1141419	65/80	68-85	84-106	16	4,9	28	C	
602-106-119-6400	1141420	80/100	84-106	99-119	16	5,3	24	C	
602-106-133-6400	1141421	100/100	84-106	109-133	16	5,3	24	C	
602-119-133-6400	1141422	100/100	99-119	109-133	16	5,6	24	C	
602-119-157-6400	1141423	100/125	99-119	132-157	16	6,4	15	C	
602-133-157-6400	1141424	100/125	109-133	132-157	16	6,4	15	C	
602-133-183-6400	1141425	100/150	109-133	157-183	16	7,4	12	C	
602-157-183-6400	1141426	125/150	132-157	157-183	16	7,7	12	C	
602-183-201-6400	1141427	150/150	157-183	176-201	16	10	12	C	
602-201-215-6400	1141428	150/200	176-201	193-215	16	10	9	C	
602-201-242-6400	1141429	150/200	176-201	218-242	16	14	7	C	
602-215-242-6400	1141430	200/200	193-215	218-242	16	11	7	C	
602-215-268-6400	1141431	200/225	193-215	242-268	16	13	14	C	
602-242-268-6400	1141432	200/225	218-242	242-268	16	14	6	C	
602-268-292-6400	1141433	225/250	242-268	266-292	16	19	6	C	
602-292-306-6400	1141434	250/250	266-292	280-306	16	20	5	C	
602-292-327-6400	1141435	250/300	266-292	301-327	16	20	5	C	
602-327-350-6400	1141436	300/300	301-327	324-350	16	17	3	C	
602-327-378-6400	1141437	300/350	301-327	352-378	16	19	6	C	
602-350-378-6400	1141438	300/350	324-350	352-378	16	20	4	C	
602-378-396-6400	1141439	350/350	352-378	372-396	16	26	2	C	
602-396-410-6400	1141440	350/350	372-396	384-410	16	26	2	C	
602-410-436-6400	1141441	350/400	384-410	410-436	16	22	2	C	
602-436-462-6400	1141442	400/400	410-436	436-462	16	23	2	C	

Serie 603/A-6400

Universal AVK Flexadapter
För rör i gråjärn, segjärn, stål,
PVC och asbestcement
Upp till PN 16
Epoxibeläggning
in- och utvändigt
Segjärn
Rostfritt stål, skruv A2/
mutter A4, grad 80
PTFE-belagd mutter
DN 40-400
Multi flänsborming PN10/16



AVK nr.	RSK nr.	DN	T mm	PN	Vikt	St/pall	Kod
		Fläns					
603-063-000-6400	1141212	40/50	46-63	16	3,8	42	C
603-074-000-6400	1141213	50	57-74	16	3,9	40	C
603-074-001-6400	1141214	50/65	57-74	16	4,1	28	C
603-085-000-6400	1141215	50/65	68-85	16	4,2	30	C
603-106-000-6400	1141216	80	84-106	16	5	24	C
603-106-001-6400	1141217	80/100	84-106	16	5,3	18	C
603-119-000-6400	1141218	100	99-119	16	5,6	24	C
603-133-000-6400	1141219	100	109-133	16	5,8	24	C
603-133-001-6400	1141220	100/125	109-133	16	8,7	15	C
603-157-000-6400	1141221	125/150	132-157	16	8,3	15	C
603-183-000-6400	1141222	150	157-183	16	9,3	12	C
603-201-000-6400	1141223	150	176-201	16	10	12	C
603-215-000-6400	1141224	200	193-215	16	12	7	C
603-242-000-6400	1141225	200	218-242	16	12	7	C
603-268-000-6400	1141226	250	242-268	16	20	4	C
603-292-000-6400	1141227	250	266-292	16	19	5	C
603-306-000-6400	1141228	250	280-306	16	19	3	C
603-327-000-6400	1141229	300	301-327	16	22	3	B
603-350-000-6400	1141230	300	324-350	16	24	3	C
603-378-000-6400	1141231	350	352-378	16	28	4	C
603-396-000-6400	1141232	350	372-396	16	30	5	C
603-410-000-6400	1141233	350	384-410	16	34	2	C
603-436-000-6400	1141234	400	410-436	16	35	2	C
603-462-000-6400	1141235	400	436-462	16	42	2	C

Serie 265/50-011

Demoneringsbox
för alla flänskopplingar i
installationer under jord eller
ovan jord
Gångstängerna är förlängda
100 mm och är tillverkade
av A2 stål
Epoxibeläggning
in- och utvändigt
PN 10/16
DN 50-250



AVK nr.	RSK nr.	DN	PN	Vikt	Kod
265-50-0050-191	1142680	50	10/16	13,7	C
265-50-0080-1A1	1142681	80	10/16	20,4	C
265-50-0100-1A1	1142682	100	10/16	24,8	C
265-50-0150-1A1	1142683	150	10/16	36,2	C
265-50-0200-0A1	1142684	200	10	52,1	C
265-50-0250-0A1	1142686	250	10	77,7	C
265-50-0200-1A1	1142685	200	16	52,1	C
265-50-0250-1A1	1142687	250	16	77,7	C

Serie 265/30-021

Demoneringsbox
för alla flänskopplingar i
installationer under jord eller
ovan jord
Gångstängerna är förlängda
100 mm och är tillverkade
av A2 stål
Epoxibeläggning
in- och utvändigt
PN 10/16
DN 300-1200



AVK nr.	RSK nr.	DN	PN	Vikt	Kod
265-30-0300-091	1142688	300	10	62	C
265-30-0350-091	1142690	350	10	69	C
265-30-0400-091	1142692	400	10	80	C
265-30-0450-091	1142694	450	10	90	C
265-30-0500-091	1142696	500	10	99	C
265-30-0600-091	1142698	600	10	140	C
265-30-0700-091	1142700	700	10	146	C
265-30-0800-091	1142702	800	10	177	C
265-30-0900-091	1142704	900	10	195	C
265-30-1000-091	1142706	1000	10	256	C
265-30-1200-091	1142708	1200	10	328	C
265-30-0300-191	1142689	300	16	60	C
265-30-0350-191	1142691	350	16	70	C
265-30-0400-191	1142693	400	16	80	C
265-30-0450-191	1142695	450	16	90	C
265-30-0500-191	1142697	500	16	117	C
265-30-0600-191	1142699	600	16	148	C
265-30-0700-191	1142701	700	16	155	C
265-30-0800-191	1142703	800	16	170	C
265-30-0900-191	1142705	900	16	190	C
265-30-1000-191	1142707	1000	16	332	C
265-30-1200-191	1142709	1200	16	290	C



SUPA MAXI™

Dragfast koppling för alla rörtyper dock inte kopparrör
 Patenterat grepp och tätningssystem för maximal trygghet
 Snabb åtdragning av kopplingen tack vare hög utväxling
 Dricksvattengodkänt gummi
 Kopplingen behöver inte efterdras
 Skyddskåpa som förhindrar att smuts kommer in i systemet
 Lyftögla på DN 100-600

Serie 631/00-001

AVK Supa Maxi™
 Universal dragfast rak
 koppling för alla rörtyper
 PN 16
 EPDM gummi, Dricksvatten
 godkänt NF-DVGW
 Hus av segjärn
 Bult A2, mutter A4,
 antifriktionsbelagda
 Gripsegment av härdat stål/brons
 Epoxy enl. DIN 30677-2 och GSK
 Snabb åtdragning av kopplingen
 tack vare hög utväxling



AVK nr.	RSK nr.	DN	T mm	PN	Vikt	St/pall	Kod
631-071-00-6	1141756	50	48-71	16	6	18	A
631-091-00-6	1141757	65	69-91	16	7	16	A
631-106-00-6	1141758	80	82-106	16	7,5	14	A
631-133-00-6	1141759	100	104-133	16	11	10	A
631-161-00-6	1141760	125	132-159	16	13	12	A
631-188-00-6	1141761	150	159-188	16	16	8	A
631-227-00-6	1141762	200	193-227	16	25	6	A
631-257-00-6	1141763	225	224-257	16	37	4	A
631-301-00-6	1141764	250	266-301	16	35	4	A
631-356-00-6	1141765	300	314-356	16	45	2	A
631-396-006	1150629	350	352-396	16	114	1	A
631-442-00-6	1142048	400	398-442	16	107	1	A
631-510-00-6	1150630	450	448-510	16	177	1	A
631-552-00-6	1150631	500	498-552	16	201	1	A
631-652-00-6	1150632	600	604-652	16	241	1	A

Serie 631/70-004

AVK Supa Maxi™
 Universal dragfast rak
 koppling för alla rörtyper
 PN 16
 NBR gummi PN 10
 Hus av segjärn
 Bult A2, mutter A4,
 antifriktionsbelagda
 Gripsegment av härdat stål/brons
 Epoxy enl. DIN 30677-2 och GSK
 Snabb åtdragning av kopplingen
 tack vare hög utväxling



AVK nr.	RSK nr.	DN	T mm	PN	Vikt	St/pall	Kod
631-071-70-2	1141827	50	48-71	10	6	18	B
631-091-70-2	1141828	65	69-91	10	7	16	B
631-106-70-2	1141829	80	82-106	10	7,5	14	B
631-133-70-2	1141830	100	104-133	10	11	10	B
631-161-70-2	1141831	125	132-159	10	13	12	B
631-188-70-2	1141832	150	159-188	10	16	8	B
631-227-70-2	1141833	200	193-227	10	25	6	B
631-257-70-2	1141834	225	224-257	10	30	4	B
631-301-70-2	1141835	250	266-301	10	35	4	B
631-356-70-2	1141836	300	314-356	10	45	2	B

Serie 632/00-001

AVK Supa Maxi™
 Universal dragfast förminskad
 koppling
 för alla rörtyper
 PN 16
 EPDM gummi, Dricksvatten
 godkänt NF-DVGW
 Hus av segjärn
 Bult A2, mutter A4,
 antifriktionsbelagda
 Gripsegment av härdat stål/brons
 Epoxy enl. DIN 30677-2 och GSK
 Snabb åtdragning av kopplingen
 tack vare hög utväxling



AVK nr.	RSK nr.	DN	T1 mm	T2 mm	PN	Vikt	St/pall	Kod
632-071-091-006	1141766	50-65	48-71	69-91	16	6,5	14	A
632-071-106-006	1141767	50-80	48-71	82-106	16	7	14	A
632-091-106-006	1141768	65-100	69-91	82-106	16	7,5	12	A
632-106-133-006	1141769	80-100	82-106	104-133	16	10	10	A
632-133-161-006	1141770	100-125	104-133	132-159	16	13	10	A
632-133-188-006	1141771	100-150	104-133	159-188	16	14	8	A
632-161-188-006	1141772	125-150	132-159	159-188	16	15	8	A
632-188-227-006	1141773	150-200	159-188	193-227	16	21	6	A
632-188-257-006	1141774	150-225	159-188	224-257	16	27	6	A
632-227-257-006	1141775	200-225	193-227	224-257	16	32	4	A
632-227-301-006	1141776	200-250	193-227	266-301	16	32	4	A
632-257-301-006	1141777	225-250	224-257	266-301	16	36	2	A
632-301-356-006	1141778	250-300	266-301	314-356	16	42	2	A

Serie 632/70-004 gas

AVK Supa Maxi™

Universal dragfast

förminskad koppling

för alla rörtyper

PN 16NBR gummi PN 10

Hus av segjärn

Bult A2, mutter A4,

antifrikationsbelagda

Gripsegment av härdat stål/brons

Epoxy enl. DIN 30677-2 och GSK

Snabb åtdragning av kopplingen

tack vare hög utväxling



AVK nr.	RSK nr.	DN	T1 mm	T2 mm	PN	Vikt	St/pall	Kod
632-071-091-702	1141837	50-65	48-71	69-91	10	6,5	14	C
632-071-106-702	1141938	50-80	48-71	82-106	10	7	14	C
632-091-106-702	1141839	65-100	69-91	82-106	10	7,5	12	C
632-106-133-702	1141840	80-100	82-106	104-133	10	10	10	C
632-133-161-702	1141841	100-125	104-133	132-159	10	13	10	C
632-133-188-702	1141842	100-150	104-133	159-188	10	14	8	C
632-161-188-702	1141843	125-150	132-159	159-188	10	15	8	C
632-188-227-702	1141844	150-200	159-188	193-227	10	21	6	C
632-188-257-702	1141845	150-225	159-188	224-257	10	27	4	C
632-227-257-702	1141846	200-225	193-227	224-257	10	32	4	C
632-227-301-702	1141847	200-250	193-227	266-301	10	32	4	C
632-257-301-702	1141848	225-250	224-257	266-301	10	36	3	C
632-301-356-702	1141849	250-300	266-301	314-356	10	42	2	C

Serie 633/00-001

AVK Supa Maxi™

Universal dragfast flänskoppling

för alla rörtyper

PN 16

EPDM gummi - Dricksvatten godkänt

NF-DVGW

Hus av segjärn

Bult A2, mutter A4,

antifrikationsbelagda

Gripsegment av härdat stål/brons

Epoxy enl. DIN 30677-2 och GSK

Snabb åtdragning av kopplingen

tack vare hög utväxling



AVK nr.	RSK nr.	DN	Fläns	T mm	PN	Vikt	St/pall	Kod
633-071-00-006 ¹	1141779	40	DN 40/50	48-71	16	5	30	A
633-091-00-006 ²	1141780	65	DN 50/65	69-91	16	6	24	A
633-106-00-006	1141781	80		82-106	16	6,5	20	A
633-133-01-006	1142047	80		104-133	16	9	15	A
633-133-00-006	1141782	100		104-133	16	9	15	A
633-161-00-006	1141783	100		132-159	16	11	12	A
633-161-01-006	1150633	150		132-159	16	11	8	A
633-188-00-006	1141784	150		159-188	16	12	8	A
633-227-00-006	1141785	200		193-227	16	19	6	A
633-257-01-006	1150634	200		224-257	16	25	4	A
633-257-00-006 ³	1141786	225	DN 250	224-257	16	25	4	A
633-301-00-006	1141787	250		266-301	16	28	3	A
633-356-00-006	1141788	300		314-356	16	38	2	A
633-396-00-006	1150635	350		352-396	16	87	1	A
633-442-00-006	1143044	400		392-442	16	80	1	A
633-510-00-006	1150636	450		448-510	16	145	1	A
633-552-00-006	1150637	500		498-552	16	166	1	A
633-652-00-006	1150638	600		604-652	16	213	1	A

¹ DN 40/50² DN 50/65³ DN250 Fläns**Serie 633/70-004**

AVK Supa Maxi™

Universal dragfast flänskoppling

för alla rörtyper

PN 16

NBR gummi PN 10

Hus av segjärn

Bult A2, mutter A4,

antifrikationsbelagda

Gripsegment av härdat stål/brons

Epoxy enl. DIN 30677-2 och GSK

Snabb åtdragning av kopplingen

tack vare hög utväxling



AVK nr.	RSK nr.	DN	Fläns	T mm	PN	Vikt	St/pall	Kod
633-071-70-002 ¹	1141850	40	DN 40/50	48-71	10	5	30	B
633-091-70-002 ²	1141851	65	DN 50/65	69-91	10	6	24	C
633-106-70-002	1141852	80		82-106	10	6,5	20	B
633-133-70-002	1141853	100		104-133	10	9	15	B
633-161-70-002	1141854	100		132-159	10	11	12	C
633-161-71-002	1150639	150		132-159	10	11	8	B
633-188-70-002	1141855	150		159-188	10	12	8	B
633-227-70-002	1141856	200		193-227	10	19	6	B
633-257-71-002	1150640	200		224-257	10	25	4	B
633-257-70-002 ³	1141857	225	DN 250	224-257	10	25	4	B
633-301-70-002	1141858	250		266-301	10	28	3	B
633-356-70-002	1141859	300		314-356	10	38	2	B
633-442-70-002	1150641	400		392-442	10	80	1	C

¹ DN 40/50² DN 50/65³ DN250 Fläns

Serie 634/00-001

AVK Supa Maxi™
 Universal dragfast ändhuv
 för alla rörtyper
 EPDM gummi - Dricksvatten
 godkänt NF-DVGW
 PN 16
 Hus av segjärn
 Bult A2, mutter A4,
 antifriktionsbelagda
 Gripsegment av härdat stål/brons
 Epoxy enl. DIN 30677-2 och GSK
 Snabb åtdragning av koppplingen
 tack vare hög utväxling



AVK nr.	RSK nr.	DN	T mm	PN	Vikt	St/pall	Kod
634-071-00-016 ¹	1141789	50	48-71	16	4	28	A
634-091-00-016 ¹	1141790	65	69-91	16	5	24	B
634-091-00-036 ²	1141791	65	69-91	16	5	24	A
634-106-00-016 ¹	1141792	80	82-106	16	5,5	20	C
634-106-00-036 ²	1141793	80	82-106	16	5,5	20	A
634-133-00-016 ¹	1141794	100	104-133	16	8	15	C
634-133-00-036 ²	1141795	100	104-133	16	8	15	A
634-161-00-016 ¹	1141796	125	132-159	16	9	12	C
634-161-00-036 ²	1141797	125	132-159	16	9	12	A
634-188-00-016 ¹	1141798	150	159-188	16	11	8	C
634-188-00-036 ²	1141799	150	159-188	16	11	8	A
634-227-00-016 ¹	1141800	200	193-227	16	16	6	C
634-227-00-036 ²	1141801	200	193-227	16	16	6	B
634-257-00-016 ¹	1141802	225	224-257	16	19	4	C
634-257-00-036 ²	1141803	225	224-257	16	19	4	B
634-301-00-016 ¹	1141804	250	266-301	16	22	3	C
634-301-00-036 ²	1141805	250	266-301	16	22	3	B
634-356-00-016 ¹	1141806	300	314-356	16	29	2	C
634-356-00-036 ²	1141807	300	314-356	16	29	2	B
634-396-00-016 ¹	1105385	350	352-396	16	65	1	C
634-396-00-036 ²	1105386	350	352-396	16	65	1	C
634-442-00-016 ¹	1143045	400	392-442	16	58	1	C
634-442-00-036 ²	1143046	400	392-442	16	58	1	C

¹ 1 1/4" BSP-gänga, parallellt med röret
² 2" BSP-gänga, parallellt med röret

Serie 634/70-004

AVK Supa Maxi™
 Universal dragfast ändhuv
 för alla rörtyper
 PN 16
 NBR gummi PN 10
 Hus av segjärn
 Bult A2, mutter A4,
 antifriktionsbelagda
 Gripsegment av härdat stål/brons
 Epoxy enl. DIN 30677-2 och GSK
 Snabb åtdragning av koppplingen
 tack vare hög utväxling



AVK nr.	RSK nr.	DN	T mm	PN	Vikt	St/pall	Kod
634-071-70-012 ¹	1141860	50	48-71	10	4	28	A
634-091-70-012 ¹	1141861	65	69-91	10	5	24	B
634-091-70-032 ²	1141862	65	69-91	10	5	24	B
634-106-70-012 ¹	1141863	80	82-106	10	5,5	20	A
634-106-70-032 ²	1141864	80	82-106	10	5,5	20	A
634-133-70-012 ¹	1141865	100	104-133	10	8	15	B
634-133-70-032 ²	1141866	100	104-133	10	8	15	B
634-161-70-012 ¹	1141867	125	132-159	10	9	12	C
634-161-70-032 ²	1141868	125	132-159	10	9	12	C
634-188-70-012 ¹	1141869	150	159-188	10	11	8	B
634-188-70-032 ²	1141870	150	159-188	10	11	8	B
634-227-70-012 ¹	1141871	200	193-227	10	16	6	C
634-227-70-032 ²	1141872	200	193-227	10	16	6	C
634-257-70-012 ¹	1141873	225	224-257	10	19	4	B
634-257-70-032 ²	1141874	225	224-257	10	19	4	B
634-301-70-012 ¹	1141875	250	266-301	10	22	3	C
634-301-70-032 ²	1141876	250	266-301	10	22	3	C
634-356-70-012 ¹	1141877	300	314-356	10	29	2	B
634-356-70-032 ²	1141878	300	314-356	10	29	2	B

¹ 1 1/4" BSP-gänga, parallellt med röret
² 2" BSP-gänga, parallellt med röret

Serie 635/00-002

AVK Supa Maxi™
 Universal dragfast koppling/
 PE-ända
 PE100, PN 10, **SDR 17**
 för alla rörtyper
 PN 10
 EPDM gummi – Dricksvatten
 godkänt NF-DVGW
 Hus av segjärn
 Bult A2, mutter A4,
 antifriktionsbelagda
 Gripsegment av härdat stål/brons
 Epoxy enl. DIN 30677-2 och GSK
 Snabb åtdragning av koppplingen
 tack vare hög utväxling



AVK nr.	RSK nr.	DN/PE-rör	T mm	PN	Vikt	St/pall	Kod
635-071-00-266	1141889	50-63	48-71	10	4,5	13	C
635-091-00-266	1141890	65-75	69-91	10	5,6	11	C
635-105-00-266	1141910	80-110	82-106	10	7,5	10	A
635-106-00-266	1141891	80-90	82-106	10	6	9	B
635-133-00-266	1141892	100-110	104-133	10	10	9	A
635-161-00-266	1141893	125-160	132-159	10	16	6	B
635-188-00-266	1141894	150-160	159-188	10	18	5	A
635-227-00-266	1141895	200-200	193-227	10	27	4	B
635-257-00-266	1141896	225-250	224-257	10	48	2	A
635-301-00-266	1141897	250-250	266-301	10	49	2	C
635-356-00-266	1141898	300-315	314-356	10	64	1	C

Serie 635/00-001

AVK Supa Maxi™

Universal dragfast koppling/
PE-ända

PE-ända

PE100, PN 16, **SDR 11**

för alla rörtyper

PN 16

EPDM gummi – Dricksvatten

godkänt NF-DVGW

Hus av segjärn

Bult A2, mutter A4,

antifraktionsbelagda

Gripsegment av hårdat stål/brons

Epoxy enl DIN 30677-2 och GSK

Snabb åtdragning av kopplingen

tack vare hög utväxling



AVK nr.	RSK nr.	DN/PE-rör	T mm	PN	Vikt	St/pall	Kod
635-071-00-166	1141879	50-63	48-71	16	4,5	13	B
635-091-00-166	1141880	65-75	69-91	16	5,6	11	B
635-105-00-166	1141909	80-110	82-106	16	7,5	10	C
635-106-00-166	1141881	80-90	82-106	16	6	9	B
635-133-00-166	1141882	100-110	104-133	16	10	9	C
635-161-00-166	1141883	125-160	132-159	16	16	6	C
635-188-00-166	1141884	150-160	159-188	16	18	5	B
635-227-00-166	1141885	200-200	193-227	16	27	4	C
635-257-00-166	1141886	225-250	224-257	16	48	2	C
635-301-00-166	1141887	250-250	266-301	16	49	2	B
635-356-00-166	1141888	300-315	314-356	16	64	1	B



SUPA LOCK™

Supa Lock™-systemet, med sin patenterade konstruktion garanterar ett 100% korrosionsfritt förband i kombination med snabb och enkel montering med maximal flexibilitet. Med sin enkla och smarta konstruktion erbjuder Supa Lock™ långsiktig säkerhet med optimalt skydd mot korrosion och läckage samt skydd mot oavsiktlig demontering av anslutningen när rörledningen trycksätts.

DIN / AVK SUPA LOCK

Serie 103/00-034
 Servisventil
Duplex spindel 1.4362
 Segjärn
 Supa Lock Hona/Hane



AVK nr.	RSK nr.	DN	Vikt	St/pall	Kod
103-032-00-00046434	4328561	32	3,2	58	C

Serie 103/50-034
 Servisventil
Duplex spindel 1.4362
 Segjärn
 Supa Lock Hane/PRK



AVK nr.	RSK nr.	DN	Rör mm	Vikt	St/pall	Kod
103-032-50-500464	4328565	32	32	3,5	58	B
103-032-50-510464	4328566	32	40	3,5	53	B

Serie 100/00
 Anbörning för PE/PVC rör
 Segjärn
 DN32 Supa Lock Hona









AVK nr.	RSK nr.	DN	Rör mm	Vikt	St/pall	Kod
100-063-00-320464	2401523	32	63	2,1	150	B
100-075-00-320464	2401524	32	75	2,3	100	B
100-090-00-320464	2401525	32	90	2,7	150	B
100-110-00-320464	2401526	32	110	3,6	175	B
100-125-00-320464	2401527	32	125	3,8	50	B
100-140-00-320464	2401528	32	140	5,4	50	B
100-160-00-320464	2401529	32	160	5,9	76	B
100-200-00-320464	2401530	32	200	9,3	30	B
100-225-00-320464	2401531	32	225	11	30	B

Serie 100/85-001
 Anbörningsbygel med
 kniv, metallrör
 Segjärn
 DN32 Supa Lock Hona



AVK nr.	RSK nr.	DN	Tolerans mm	Vikt	Kod
100-088-85-320464		50	50-88	2,3	B
100-188-85-320464		80	88-118	2,3	B
100-133-85-320464		100	105-133	2,4	B
100-159-85-320464		125	133-159	2,4	B
100-186-85-320464		150	156-186	2,7	B
100-216-85-320464		175	186-216	2,7	B
100-244-85-320464		200	210-244	2,7	B
100-270-85-320464		225	240-270	2,8	B
100-298-85-320464		250	265-298	2,8	B
100-330-85-320464		275	299-330	3,0	B
100-345-85-320464		300	315-345	3,0	B
100-360-85-320464		300	325-360	3,0	B

<p>Serie 107/74-003 Anbörningsadapter med avstängning Segjärn</p> 	<table border="1"> <thead> <tr> <th>AVK nr.</th> <th>RSK nr.</th> <th>DN</th> <th>Vikt</th> <th>St/pall</th> <th>Kod</th> </tr> </thead> <tbody> <tr> <td>107-005-74-32464</td> <td>2169372</td> <td>32</td> <td>2</td> <td>128</td> <td>B</td> </tr> </tbody> </table>	AVK nr.	RSK nr.	DN	Vikt	St/pall	Kod	107-005-74-32464	2169372	32	2	128	B																							
AVK nr.	RSK nr.	DN	Vikt	St/pall	Kod																															
107-005-74-32464	2169372	32	2	128	B																															
<p>Serie 730/5-02 Kniv till anbörning under tryck Segjärn</p> 	<table border="1"> <thead> <tr> <th>AVK nr.</th> <th>RSK nr.</th> <th>DN/DN</th> <th>Vikt</th> <th>St/pall</th> <th>Kod</th> </tr> </thead> <tbody> <tr> <td>730-0-0-1</td> <td>1253996</td> <td>50-300</td> <td>0,3</td> <td>100</td> <td>B</td> </tr> </tbody> </table>	AVK nr.	RSK nr.	DN/DN	Vikt	St/pall	Kod	730-0-0-1	1253996	50-300	0,3	100	B																							
AVK nr.	RSK nr.	DN/DN	Vikt	St/pall	Kod																															
730-0-0-1	1253996	50-300	0,3	100	B																															
<p>Serie 107/21-003 Rak instickskoppling Segjärn</p> 	<table border="1"> <thead> <tr> <th>AVK nr.</th> <th>RSK nr.</th> <th>DN</th> <th>Rör mm</th> <th>Vikt</th> <th>St/pall</th> <th>Kod</th> </tr> </thead> <tbody> <tr> <td>107-032-21-32464</td> <td>2169355</td> <td>32</td> <td>32</td> <td>0,6</td> <td>180</td> <td>B</td> </tr> <tr> <td>107-040-21-32464</td> <td>2169356</td> <td>32</td> <td>40</td> <td>0,7</td> <td>150</td> <td>B</td> </tr> <tr> <td>107-050-21-32464</td> <td>2169357</td> <td>32</td> <td>50</td> <td>1,2</td> <td>88</td> <td>B</td> </tr> <tr> <td>107-063-21-32464</td> <td>2169358</td> <td>32</td> <td>63</td> <td>1,6</td> <td>80</td> <td>B</td> </tr> </tbody> </table>	AVK nr.	RSK nr.	DN	Rör mm	Vikt	St/pall	Kod	107-032-21-32464	2169355	32	32	0,6	180	B	107-040-21-32464	2169356	32	40	0,7	150	B	107-050-21-32464	2169357	32	50	1,2	88	B	107-063-21-32464	2169358	32	63	1,6	80	B
AVK nr.	RSK nr.	DN	Rör mm	Vikt	St/pall	Kod																														
107-032-21-32464	2169355	32	32	0,6	180	B																														
107-040-21-32464	2169356	32	40	0,7	150	B																														
107-050-21-32464	2169357	32	50	1,2	88	B																														
107-063-21-32464	2169358	32	63	1,6	80	B																														
<p>Serie 107/31-003 90° instickskoppling Segjärn</p> 	<table border="1"> <thead> <tr> <th>AVK nr.</th> <th>RSK nr.</th> <th>DN</th> <th>Rör mm</th> <th>Vikt</th> <th>St/pall</th> <th>Kod</th> </tr> </thead> <tbody> <tr> <td>107-032-31-32464</td> <td>2169359</td> <td>32</td> <td>32</td> <td>1</td> <td>150</td> <td>B</td> </tr> <tr> <td>107-040-31-32464</td> <td>2169360</td> <td>32</td> <td>40</td> <td>1,1</td> <td>88</td> <td>B</td> </tr> <tr> <td>107-050-31-32464</td> <td>2169361</td> <td>32</td> <td>50</td> <td>1,4</td> <td>40</td> <td>B</td> </tr> <tr> <td>107-063-31-32464</td> <td>2169362</td> <td>32</td> <td>63</td> <td>2</td> <td>88</td> <td>B</td> </tr> </tbody> </table>	AVK nr.	RSK nr.	DN	Rör mm	Vikt	St/pall	Kod	107-032-31-32464	2169359	32	32	1	150	B	107-040-31-32464	2169360	32	40	1,1	88	B	107-050-31-32464	2169361	32	50	1,4	40	B	107-063-31-32464	2169362	32	63	2	88	B
AVK nr.	RSK nr.	DN	Rör mm	Vikt	St/pall	Kod																														
107-032-31-32464	2169359	32	32	1	150	B																														
107-040-31-32464	2169360	32	40	1,1	88	B																														
107-050-31-32464	2169361	32	50	1,4	40	B																														
107-063-31-32464	2169362	32	63	2	88	B																														
<p>Serie 107/36 Koppling med PE-ända Segjärn</p> 	<table border="1"> <thead> <tr> <th>AVK nr.</th> <th>RSK nr.</th> <th>DN</th> <th>Rör mm</th> <th>Vikt</th> <th>St/pall</th> <th>Kod</th> </tr> </thead> <tbody> <tr> <td>107-032-36-32464</td> <td>2169363</td> <td>32</td> <td>32</td> <td>1,4</td> <td>62</td> <td>B</td> </tr> <tr> <td>107-040-36-32464</td> <td>2169364</td> <td>32</td> <td>40</td> <td>1,3</td> <td>30</td> <td>B</td> </tr> </tbody> </table>	AVK nr.	RSK nr.	DN	Rör mm	Vikt	St/pall	Kod	107-032-36-32464	2169363	32	32	1,4	62	B	107-040-36-32464	2169364	32	40	1,3	30	B														
AVK nr.	RSK nr.	DN	Rör mm	Vikt	St/pall	Kod																														
107-032-36-32464	2169363	32	32	1,4	62	B																														
107-040-36-32464	2169364	32	40	1,3	30	B																														
<p>Serie 106/01-004 Koppling with PRK-mutter Segjärn</p> 	<table border="1"> <thead> <tr> <th>AVK nr.</th> <th>RSK nr.</th> <th>DN</th> <th>Rör mm</th> <th>Vikt</th> <th>St/pall</th> <th>Kod</th> </tr> </thead> <tbody> <tr> <td>106-032-01-32464</td> <td>2169343</td> <td>32</td> <td>32</td> <td>1,3</td> <td>88</td> <td>B</td> </tr> <tr> <td>106-040-01-32464</td> <td>2169344</td> <td>32</td> <td>40</td> <td>1,3</td> <td>88</td> <td>B</td> </tr> </tbody> </table>	AVK nr.	RSK nr.	DN	Rör mm	Vikt	St/pall	Kod	106-032-01-32464	2169343	32	32	1,3	88	B	106-040-01-32464	2169344	32	40	1,3	88	B														
AVK nr.	RSK nr.	DN	Rör mm	Vikt	St/pall	Kod																														
106-032-01-32464	2169343	32	32	1,3	88	B																														
106-040-01-32464	2169344	32	40	1,3	88	B																														
<p>Serie 106/02-004 Koppling med PRK-mutter Mässing</p> 	<table border="1"> <thead> <tr> <th>AVK nr.</th> <th>RSK nr.</th> <th>DN</th> <th>Rör mm</th> <th>Vikt</th> <th>St/pall</th> <th>Kod</th> </tr> </thead> <tbody> <tr> <td>106-032-02-324</td> <td>2169349</td> <td>32</td> <td>32</td> <td>0,7</td> <td>40</td> <td>B</td> </tr> <tr> <td>106-040-02-324</td> <td>2169350</td> <td>32</td> <td>40</td> <td>0,6</td> <td>88</td> <td>B</td> </tr> <tr> <td>106-050-02-324</td> <td>2169351</td> <td>32</td> <td>50</td> <td>1,1</td> <td>88</td> <td>B</td> </tr> </tbody> </table>	AVK nr.	RSK nr.	DN	Rör mm	Vikt	St/pall	Kod	106-032-02-324	2169349	32	32	0,7	40	B	106-040-02-324	2169350	32	40	0,6	88	B	106-050-02-324	2169351	32	50	1,1	88	B							
AVK nr.	RSK nr.	DN	Rör mm	Vikt	St/pall	Kod																														
106-032-02-324	2169349	32	32	0,7	40	B																														
106-040-02-324	2169350	32	40	0,6	88	B																														
106-050-02-324	2169351	32	50	1,1	88	B																														
<p>Serie 106/02-005 Koppling med skruvkoppling Mässing</p> 	<table border="1"> <thead> <tr> <th>AVK nr.</th> <th>RSK nr.</th> <th>DN</th> <th>Rör mm</th> <th>Vikt</th> <th>St/pall</th> <th>Kod</th> </tr> </thead> <tbody> <tr> <td>106-132-02-324</td> <td>2169352</td> <td>32</td> <td>32</td> <td>0,8</td> <td>100</td> <td>C</td> </tr> <tr> <td>106-140-02-324</td> <td>2169353</td> <td>32</td> <td>40</td> <td>0,7</td> <td>88</td> <td>C</td> </tr> <tr> <td>106-150-02-324</td> <td>2169354</td> <td>32</td> <td>50</td> <td>1,4</td> <td>88</td> <td>C</td> </tr> </tbody> </table>	AVK nr.	RSK nr.	DN	Rör mm	Vikt	St/pall	Kod	106-132-02-324	2169352	32	32	0,8	100	C	106-140-02-324	2169353	32	40	0,7	88	C	106-150-02-324	2169354	32	50	1,4	88	C							
AVK nr.	RSK nr.	DN	Rör mm	Vikt	St/pall	Kod																														
106-132-02-324	2169352	32	32	0,8	100	C																														
106-140-02-324	2169353	32	40	0,7	88	C																														
106-150-02-324	2169354	32	50	1,4	88	C																														

<p>Serie 100/14 Anbörning för stålrör Segjärn</p> 	<table border="1"> <thead> <tr> <th>AVK nr.</th> <th>RSK nr.</th> <th>DN</th> <th>mm</th> <th>Vikt</th> <th>St/pall</th> <th>Kod</th> </tr> </thead> <tbody> <tr> <td>100-067-14-320464</td> <td>4585660</td> <td>32</td> <td>60-67</td> <td>1,7</td> <td>56</td> <td>C</td> </tr> <tr> <td>100-083-14-320464</td> <td>4585661</td> <td>32</td> <td>76-83</td> <td>1,6</td> <td>30</td> <td>C</td> </tr> <tr> <td>100-099-14-320464</td> <td>4585662</td> <td>32</td> <td>88-99</td> <td>1,6</td> <td>55</td> <td>C</td> </tr> <tr> <td>100-119-14-320464</td> <td>4585663</td> <td>32</td> <td>114-119</td> <td>1,8</td> <td>88</td> <td>C</td> </tr> <tr> <td>100-171-14-320464</td> <td>4585664</td> <td>32</td> <td>168-171</td> <td>2,2</td> <td>30</td> <td>C</td> </tr> <tr> <td>100-223-14-320464</td> <td>4585665</td> <td>32</td> <td>219-223</td> <td>2,6</td> <td>88</td> <td>C</td> </tr> </tbody> </table>	AVK nr.	RSK nr.	DN	mm	Vikt	St/pall	Kod	100-067-14-320464	4585660	32	60-67	1,7	56	C	100-083-14-320464	4585661	32	76-83	1,6	30	C	100-099-14-320464	4585662	32	88-99	1,6	55	C	100-119-14-320464	4585663	32	114-119	1,8	88	C	100-171-14-320464	4585664	32	168-171	2,2	30	C	100-223-14-320464	4585665	32	219-223	2,6	88	C							
AVK nr.	RSK nr.	DN	mm	Vikt	St/pall	Kod																																																			
100-067-14-320464	4585660	32	60-67	1,7	56	C																																																			
100-083-14-320464	4585661	32	76-83	1,6	30	C																																																			
100-099-14-320464	4585662	32	88-99	1,6	55	C																																																			
100-119-14-320464	4585663	32	114-119	1,8	88	C																																																			
100-171-14-320464	4585664	32	168-171	2,2	30	C																																																			
100-223-14-320464	4585665	32	219-223	2,6	88	C																																																			
<p>Serie 109/10 Distans för flänsad anslutning Segjärn</p> 	<table border="1"> <thead> <tr> <th>AVK nr.</th> <th>RSK nr.</th> <th>DN</th> <th>Avstick DN</th> <th>Vikt</th> <th>St/pall</th> <th>Kod</th> </tr> </thead> <tbody> <tr> <td>109-080-10-32064</td> <td>2169365</td> <td>80</td> <td>32</td> <td>3,1</td> <td>55</td> <td>C</td> </tr> <tr> <td>109-100-10-32064</td> <td>2169366</td> <td>100</td> <td>32</td> <td>3,5</td> <td>126</td> <td>C</td> </tr> <tr> <td>109-150-10-32064</td> <td>2169367</td> <td>150</td> <td>32</td> <td>5,4</td> <td>50</td> <td>C</td> </tr> <tr> <td>109-200-10-32064</td> <td>2169368</td> <td>200</td> <td>32</td> <td>7,1</td> <td>55</td> <td>C</td> </tr> <tr> <td>109-250-10-32064</td> <td>2169369</td> <td>250</td> <td>32</td> <td>8,5</td> <td>50</td> <td>C</td> </tr> <tr> <td>109-300-10-32064</td> <td>2169370</td> <td>300</td> <td>32</td> <td>10</td> <td>50</td> <td>C</td> </tr> <tr> <td>109-400-10-32064</td> <td>2169371</td> <td>400</td> <td>32</td> <td>16</td> <td>88</td> <td>C</td> </tr> </tbody> </table>	AVK nr.	RSK nr.	DN	Avstick DN	Vikt	St/pall	Kod	109-080-10-32064	2169365	80	32	3,1	55	C	109-100-10-32064	2169366	100	32	3,5	126	C	109-150-10-32064	2169367	150	32	5,4	50	C	109-200-10-32064	2169368	200	32	7,1	55	C	109-250-10-32064	2169369	250	32	8,5	50	C	109-300-10-32064	2169370	300	32	10	50	C	109-400-10-32064	2169371	400	32	16	88	C
AVK nr.	RSK nr.	DN	Avstick DN	Vikt	St/pall	Kod																																																			
109-080-10-32064	2169365	80	32	3,1	55	C																																																			
109-100-10-32064	2169366	100	32	3,5	126	C																																																			
109-150-10-32064	2169367	150	32	5,4	50	C																																																			
109-200-10-32064	2169368	200	32	7,1	55	C																																																			
109-250-10-32064	2169369	250	32	8,5	50	C																																																			
109-300-10-32064	2169370	300	32	10	50	C																																																			
109-400-10-32064	2169371	400	32	16	88	C																																																			
<p>Serie 343/81 Kulventil med BSP gänga Mässing</p> 	<table border="1"> <thead> <tr> <th>AVK nr.</th> <th>RSK nr.</th> <th>DN</th> <th>BSP</th> <th>Vikt</th> <th>St/pall</th> <th>Kod</th> </tr> </thead> <tbody> <tr> <td>343-025-81-00</td> <td>5493227</td> <td>25</td> <td>1"</td> <td>1,7</td> <td>88</td> <td>C</td> </tr> <tr> <td>343-032-81-00</td> <td>5493228</td> <td>32</td> <td>1¼"</td> <td>2,1</td> <td>88</td> <td>C</td> </tr> <tr> <td>343-040-81-00</td> <td>5493229</td> <td>40</td> <td>1½"</td> <td>3</td> <td>88</td> <td>C</td> </tr> </tbody> </table>	AVK nr.	RSK nr.	DN	BSP	Vikt	St/pall	Kod	343-025-81-00	5493227	25	1"	1,7	88	C	343-032-81-00	5493228	32	1¼"	2,1	88	C	343-040-81-00	5493229	40	1½"	3	88	C																												
AVK nr.	RSK nr.	DN	BSP	Vikt	St/pall	Kod																																																			
343-025-81-00	5493227	25	1"	1,7	88	C																																																			
343-032-81-00	5493228	32	1¼"	2,1	88	C																																																			
343-040-81-00	5493229	40	1½"	3	88	C																																																			
<p>Serie 343/84 Kulventil med PRK-mutter Mässing</p> 	<table border="1"> <thead> <tr> <th>AVK nr.</th> <th>RSK nr.</th> <th>DN</th> <th>Rör mm</th> <th>Vikt</th> <th>St/pall</th> <th>Kod</th> </tr> </thead> <tbody> <tr> <td>343-025-84-00</td> <td>5493230</td> <td>25</td> <td>32</td> <td>1,8</td> <td>88</td> <td>C</td> </tr> <tr> <td>343-032-84-00</td> <td>5493231</td> <td>32</td> <td>40</td> <td>2,1</td> <td>88</td> <td>C</td> </tr> <tr> <td>343-040-84-00</td> <td>5493232</td> <td>40</td> <td>50</td> <td>3</td> <td>5</td> <td>C</td> </tr> </tbody> </table>	AVK nr.	RSK nr.	DN	Rör mm	Vikt	St/pall	Kod	343-025-84-00	5493230	25	32	1,8	88	C	343-032-84-00	5493231	32	40	2,1	88	C	343-040-84-00	5493232	40	50	3	5	C																												
AVK nr.	RSK nr.	DN	Rör mm	Vikt	St/pall	Kod																																																			
343-025-84-00	5493230	25	32	1,8	88	C																																																			
343-032-84-00	5493231	32	40	2,1	88	C																																																			
343-040-84-00	5493232	40	50	3	5	C																																																			
<p>Serie 343/85 Kulventil med skruvkoppling Mässing</p> 	<table border="1"> <thead> <tr> <th>AVK nr.</th> <th>RSK nr.</th> <th>DN</th> <th>Rör mm</th> <th>Vikt</th> <th>St/pall</th> <th>Kod</th> </tr> </thead> <tbody> <tr> <td>343-025-85-00</td> <td>5493233</td> <td>32</td> <td>32</td> <td>2</td> <td>88</td> <td>C</td> </tr> <tr> <td>343-032-85-00</td> <td>5493234</td> <td>32</td> <td>40</td> <td>2,2</td> <td>88</td> <td>C</td> </tr> <tr> <td>343-040-85-00</td> <td>5493235</td> <td>32</td> <td>50</td> <td>3</td> <td>88</td> <td>C</td> </tr> </tbody> </table>	AVK nr.	RSK nr.	DN	Rör mm	Vikt	St/pall	Kod	343-025-85-00	5493233	32	32	2	88	C	343-032-85-00	5493234	32	40	2,2	88	C	343-040-85-00	5493235	32	50	3	88	C																												
AVK nr.	RSK nr.	DN	Rör mm	Vikt	St/pall	Kod																																																			
343-025-85-00	5493233	32	32	2	88	C																																																			
343-032-85-00	5493234	32	40	2,2	88	C																																																			
343-040-85-00	5493235	32	50	3	88	C																																																			
<p>Serie 106/00 Blind plugg Segjärn</p> 	<table border="1"> <thead> <tr> <th>AVK nr.</th> <th>RSK nr.</th> <th>DN</th> <th>Vikt</th> <th>St/pall</th> <th>Kod</th> </tr> </thead> <tbody> <tr> <td>106-000-00-32464</td> <td>1253995</td> <td>32</td> <td>0,8</td> <td>200</td> <td>B</td> </tr> </tbody> </table>	AVK nr.	RSK nr.	DN	Vikt	St/pall	Kod	106-000-00-32464	1253995	32	0,8	200	B																																												
AVK nr.	RSK nr.	DN	Vikt	St/pall	Kod																																																				
106-000-00-32464	1253995	32	0,8	200	B																																																				
<p>Säkerhetsbygel PP</p> 	<table border="1"> <thead> <tr> <th>AVK nr.</th> <th>RSK nr.</th> <th>Vikt</th> <th>Kod</th> </tr> </thead> <tbody> <tr> <td>107-040-03</td> <td>2293685</td> <td>0,01</td> <td>C</td> </tr> </tbody> </table>	AVK nr.	RSK nr.	Vikt	Kod	107-040-03	2293685	0,01	C																																																
AVK nr.	RSK nr.	Vikt	Kod																																																						
107-040-03	2293685	0,01	C																																																						

Borrmaskin till Supa Lock

Används vid anborrning

I väskan ligger följande:

Verktygsväska
 Spärmyckel
 Borrmaskin L = 440 mm
 1" adapter
 1½" adapter
 1" SJ / AC borkrona
 1" PE / PVC hålsåg
 3 mm T-handtag insexnyckel
 Reservdelslåda

AVK nr.	RSK nr.	Vikt	Kod
970500300200001	1167296	8,1	B

**Serie 106/01-003**

Gängad anslutning

Segjärn

Till borrmaskin

AVK nr.	RSK nr.	DN	BSP gänga	Vikt	St/pall	Kod
106-003-01-32464	2169340	32	1¼"	1,3	88	C
106-004-01-32464	2169341	32	1½"	1,3	50	C
106-005-01-32464	2169342	32	2"	1,3	50	C

Serie 106/02-003

Gängad anslutning

Mässing

Till borrmaskin

AVK nr.	RSK nr.	DN	BSP gänga	Vikt	St/pall	Kod
106-002-02-324	2169345	32	1"	0,7	88	C
106-003-02-324	2169346	32	1¼"	0,7	88	C
106-004-02-324	2169347	32	1½"	0,8	30	C
106-005-02-324	2169348	32	2"	1	88	C

DIMENSIONERING AV TELESKOPGARNITYR TILL SERVISVENTILER

Läggingsdjupet är beräknat mellan rörledningens övre yta och marknivån. Måtten kan avvika $\pm 25\text{mm}$ om en annan typ av växellåda används på ventilen.

L mm	LD mm	Galvat garnityr RSK Nr.	Rostfritt garnityr RSK Nr.
450-700	670-900	4260420	4260424
650-1100	900-1340	4260421	4260425
800-1400	1050-1640	4260433	4260434
1050-1750	1200-1900	4260422	4260426
1400-2350	1510-2530	4260432	4260431
1700-2900	1840-3190	4260423	4260427
2500-4700	2750-4950	4260437	4260438

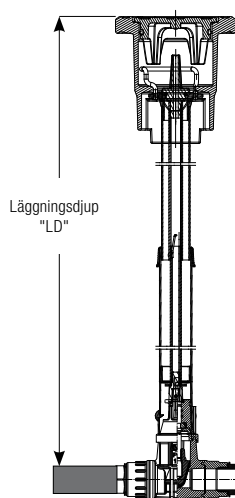

TILL SLUSSVENTILER

Garnityrets längd	L mm	L mm	L mm	L mm	L mm	L mm
	450-700	650-1100	1050-1750	1400-2350	1700-2900	2500-4700
RSK Nr. Galvat	4260286	4260287	4260288	4260289	4260290	4260296
RSK Nr. Rostfritt	4260291	4260292	4260293	4260294	4260295	4260297
RSK Nr. 450-600	4260330	4260331	4260332	saknas	4260333	saknas

Ventil DN	LD mm	LD mm	LD mm	LD mm	LD mm	LD mm
40	716-966	916-1366	1316-2016	1666-2616	1966-3166	2766-4966
50	711-961	911-1361	1311-2011	1661-2611	1961-3161	2761-4961
65	733-983	933-1383	1333-2033	1683-2633	1983-3183	2783-4983
80	752-1002	952-1402	1352-2052	1702-2652	2002-3202	2802-5002
100	779-1029	979-1429	1379-2079	1729-2679	2029-3229	2829-5029
125	808-1058	1008-1458	1408-2108	1758-2708	2058-3258	2858-5058
150	868-1118	1068-1518	1468-2168	1818-2768	2118-3318	2918-5118
200	957-1207	1157-1607	1557-2257	1907-2857	2207-3407	3007-5207
250	1034-1284	1234-1684	1634-2334	1984-2934	2284-3484	3084-5284
300	1085-1335	1285-1735	1685-2385	2035-2985	2335-3535	3135-5335
350	1250-1500	1450-1900	1850-2550	2200-3150	2500-3700	3300-5500
400	1255-1505	1455-1905	1855-2555	2205-3155	2505-3705	3305-5505
450	1437-1687	1637-2087	2037-2737	2387-3337	2687-3887	3487-5687
500	1387-1637	1587-2037	1987-2687	2337-3287	2637-3837	3437-5637
600	1480-1730	1680-2130	2080-2780	2430-3380	2730-3930	3530-5730

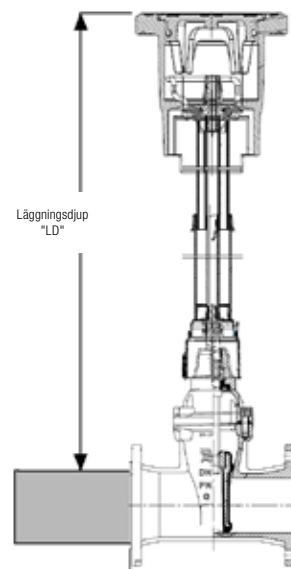

DIMENSIONERING AV TELESKOPGARNITYR TILL VRIDSPJÄLL

Läggingsdjupet är beräknat mellan rörledningens övre yta och marknivån. Måtten kan avika $\pm 25\text{mm}$ om en annan typ av växellåda används på ventilen.

	L mm	L mm	L mm	L mm
Garnityrets längd	450-700	650-1100	1050-1750	1700-2900

RSK Nr. DN200-500 (1)	4260528	4260529	4260530	4260531
RSK Nr. DN600-800 (2)	4260532	4260533	4260534	4260535

Ventil DN/PN	LD mm	LD mm	LD mm	LD mm
DN200 PN10/16 (1)	568-818	768-1218	1168-1868	1818-3018
DN250 PN10/16 (1)	543-793	743-1193	1143-1843	1793-2993
DN300 PN10 (1)	518-768	718-1168	1118-1818	1768-2968
DN300 PN16 (1)	529-779	729-1179	1129-1829	1779-2979
DN350 PN10 (1)	493-743	693-1143	1093-1793	1743-2943
DN350 PN16 (1)	504-754	704-1154	1104-1804	1754-2954
DN400 PN10/16 (1)	479-729	679-1129	1079-1779	1729-2929
DN450 PN10 (1)	454-704	654-1104	1054-1754	1704-2904
DN450 PN16 (1)	470-720	670-1120	1070-1770	1720-2920
DN500 PN10 (1)	429-679	629-1079	1029-1729	1679-2879
DN500 PN16 (1)	445-695	645-1095	1045-1745	1695-2895
DN600 PN10 (1)	395-645	595-1045	995-1695	1645-2845
DN600 PN16 (2)	422-672	622-1072	1022-1722	1672-2872
DN700 PN10 (2)	372-622	572-1022	972-1672	1622-2822
DN700 PN16 (2)	415-665	615-1065	1015-1715	1665-2865
DN800 PN10 (2)	322-572	522-972	922-1622	1572-2772
DN800 PN16 (2)	365-615	565-1015	965-1665	1615-2815
DN900 PN10 (2)	315-565	515-965	915-1615	1565-2765
DN900 PN16 (2)	428-678	628-1078	1028-1728	1678-2878
DN1000 PN10/16 (2)	378-628	578-1028	978-1678	1628-2828
DN1200 PN10/16 (2)	278-528	478-928	878-1578	1528-2728

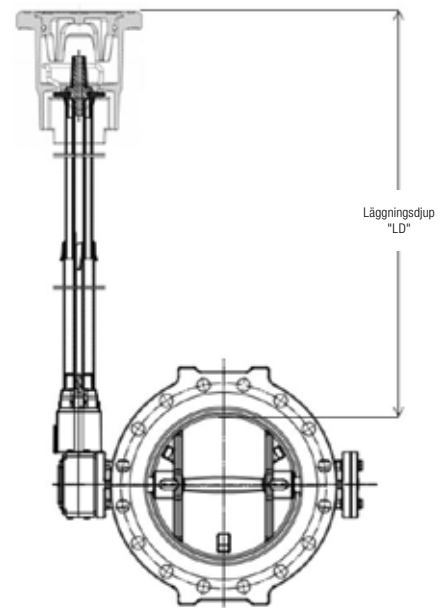

	L mm	L mm	L mm	L mm
Garnityrets längd	450-700	650-1100	1050-1750	1700-2900

RSK Nr. DN200-500 (1)	4260528	4260529	4260530	4260531
RSK Nr. DN600-800 (2)	4260532	4260533	4260534	4260535

Ventil DN/PN	LD mm	LD mm	LD mm	LD mm
DN200 PN10/16	768-1018	968-1418	1368-2068	2018-3218
DN250 PN10/16	793-1043	993-1443	1393-2093	2043-3243
DN300 PN10	818-1068	1018-1468	1418-2118	2068-3268
DN300 PN16	829-1079	1029-1479	1429-2129	2079-3279
DN350 PN10	843-1093	1043-1493	1443-2143	2093-3293
DN350 PN16	854-1104	1054-1504	1454-2154	2104-3304
DN400 PN10/16	879-1129	1079-1529	1479-2179	2129-3329
DN450 PN10	904-1154	1104-1554	1504-2204	2154-3354
DN450 PN16	920-1170	1120-1570	1520-2220	2170-3370
DN500 PN10	929-1179	1129-1579	1529-2229	2179-3379
DN500 PN16	945-1195	1145-1595	1545-2245	2195-3395
DN600 PN10	995-1245	1195-1645	1595-2295	2245-3445
DN600 PN16	1022-1272	1222-1672	1622-2322	2272-3472
DN700 PN10	1072-1322	1272-1722	1672-2372	2322-3522
DN700 PN16	1115-1365	1315-1765	1715-2415	2365-3565
DN800 PN10	1122-1372	1322-1772	1722-2422	2372-3572
DN800 PN16	1165-1415	1365-1815	1765-2465	2415-3615
DN900 PN10	1215-1465	1415-1865	1815-2515	2465-3665
DN900 PN16	1328-1578	1528-1978	1928-2628	2578-3778
DN1000 PN10/16	1378-1628	1578-2028	1978-2678	2628-3828
DN1200 PN10/16	1478-1728	1678-2128	2078-2778	2728-3928

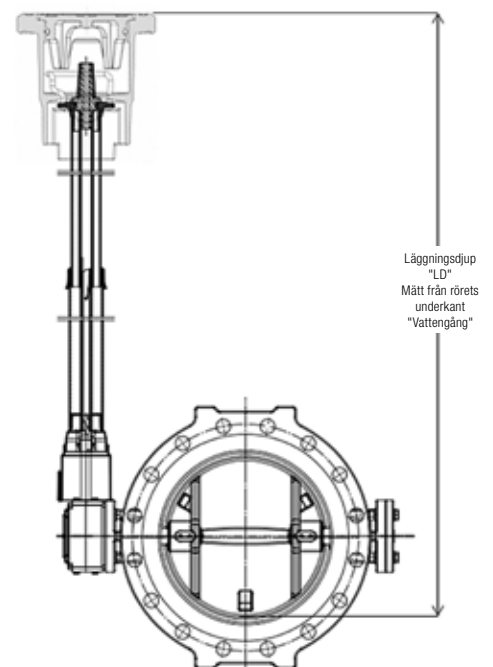

YD VATTENLEDNINGSRÖR

25 mm	Polyetenrör
26,9 mm	Stålrör DN 20
27mm	Polyeten rör
28mm	Polyetenrör
32 mm	Polyeten rör
33,7 mm	Stålrör DN 25
34 mm	Polyeten rör
40 mm	Polyetenrör
40 mm	PVG-Rör
42 mm	Polyeten rör
42,4 mm	Stålrör DN 32
48,3 mm	Stålrör DN 40
49 mm	Polyetenrör
50 mm	Polyetenrör
54 mm	Polyetenrör
55 mm	Gråjärn DN 40
57 mm	Stålrör
57 mm	Gråjärn DN 40
60 mm	Polyetenrör
60,3 mm	Stålrör DN 50
62 mm	Stålrör
63 mm	Polyetenrör
63 mm	PVG-Rör
66 mm	Segjärn DN 50
68mm	Gråjärn DN 50
70mm	Polyetenrör
75 mm	PVG-Rör
75 mm	Polyetenrör
76,1 mm	Stålrör DN 65
77mm	Gråjärn DN 65
80 mm	Polyetenrör
82 mm	AG-Rör
82 mm	Segjärn DN 65

88,9 mm	Stålrör DN 80
90 mm	Polyetenrör
90 mm	PVG-Rör
95 mm	Gråjärn DN 80
98 mm	Segjärn DN 80
101 mm	AG-Rör
101 mm	Stålrör
108mm	Stålrör
110 mm	PVG-Rör
110 mm	Polyetenrör
114,3 mm	Stålrör DN 100
118 mm	Segjärn DN 100
122 mm	Gråjärn DN 100
122 mm	AG-Rör/svarvad
123-127 mm	AG-Rör
125 mm	Polyetenrör
126mm	AG-Rör/svarvad PN 12,5
132 mm	AG-Rör/svarvad PN 15
133mm	Stålrör
139,7 mm	Stålrör DN 125
140 mm	Stålrör
140mm	Polyetenrör
140mm	PVG-Rör
144 mm	Segjärn DN 125
148mm	Gråjärn DN 125
159 mm	Stålrör DN 150
160 mm	PVG-Rör
160mm	Polyetenrör
165,1 mm	Stålrör DN 150
168,3 mm	Stålrör DN150
170mm	Segjärn DN 150
172mm	AG-Rör PN 7,5/svarvad
174mm	Gråjärn DN 150

178mm	AG-Rör PN 10/svarvad
180mm	Polyetenrör
180-186 mm	AG-Rör
184mm	AG-Rör PN 12,5/svarvad
186mm	Stålrör DN 175
190mm	AG-Rör PN 15/svarvad
193,7 mm	Stålrör DN 175
196mm	Gråjärn DN 175
200 mm	Polyetenrör
200 mm	PVG-Rör
202 mm	Gråjärn DN 175
211 mm	Stålrör DN 200
215mm	Polyetenrör
216mm	Stålrör DN 200
219,1 mm	Stålrör DN 200
222 mm	Segjärn DN 200
225 mm	PVG-Rör
225 mm	Polyetenrör
226 mm	AG-Rör PN 7,5/svarvad
228 mm	Gråjärn DN 200
236 mm	AG-Rör PN 10/svarvad
238-243 mm	AG-Rör
244 mm	AG-Rör PN 12,5/svarvad
248 mm	Gråjärn DN 225
250 mm	PVG-Rör
250 mm	Polyetenrör
254 mm	AG-Rör PN 15/svarvad
257 mm	Gråjärn DN 225
266 mm	Polyetenrör
267 mm	Stålrör DN 250
273 mm	Stålrör DN 250
274 mm	Segjärn DN 250
280 mm	PVG-Rör

YD VATTENLEDNINGSRÖR

280 mm	Polyetenrör
280 mm	AG-Rör PN 7,5/svarvad
282-284 mm	AG-Rör
284 mm	Gråjärn DN 250
288 mm	AG-Rör PN 10/svarvad
296 mm	AG-Rör PN 12,5/svarvad
306 mm	AG-Rör PN 15/svarvad
310mm	Gråjärn DN 300
315mm	PVG-Rör
315mm	Polyetenrör
318mm	Stålrör DN 300
323,9 mm	Stålrör DN 300
326 mm	Segjärn DN 300
334 mm	AG-Rör PN 7,5/svarvad
336-337 mm	AG-Rör
337 mm	Gråjärn DN 300
337-342 mm	AG-Rör
346 mm	AG-Rör PN 10/svarvad
348-354 mm	AG-Rör
355 mm	Polyetenrör
355,6 mm	Stålrör DN 350
356 mm	AG-Rör PN 12,5/svarvad
364 mm	Gråjärn DN 350
365 mm	Stålrör DN 350
368 mm	AG-Rör PN 15/svarvad
370 mm	Polyetenrör
378 mm	Segjärn DN 350
388 mm	AG-Rör PN 7,5/svarvad
390-396 mm	AG-Rör
391 mm	Gråjärn DN 350
400 mm	PVG-Rör
400 mm	Polyeten rör
404 mm	AG-Rör PN 10/svarvad

406,4 mm	Stålrör DN 400
406-412 mm	AG-Rör
414mm	AG-Rör PN 12,5/svarvad
416mm	Stålrör DN 400
419,1 mm	Stålrör DN 400
420 mm	Polyetenrör
428 mm	AG-Rör PN 15/svarvad
429 mm	Segjärn DN 400
442 mm	AG-Rör PN 7,5/svarvad
444 mm	Gråjärn DN 400
444-450 mm	AG-Rör
450 mm	PVG-Rör
450 mm	Polyeten rör
460 mm	AG-Rör PN 10/svarvad
462-468 mm	AG-Rör
471 mm	Gråjärn DN 450
474 mm	AG-Rör PN 12,5/svarvad
475 mm	Polyeten rör
479 mm	Segjärn DN 450
490 mm	AG-Rör PN 15/svarvad
496 mm	AG-Rör PN 10/svarvad
498-504 mm	AG-Rör
499 mm	Gråjärn DN 500
500 mm	PVG-Rör
500 mm	Polyeten rör
506 mm	Stålrör DN 500
508 mm	Stålrör DN 500
516mm	AG-Rör PN 10/svarvad
518-524 mm	AG-Rör
525 mm	Gråjärn DN 500
532 mm	Segjärn DN 500
548 mm	Gråjärn DN 500
550 mm	AG-Rör PN 7,5/svarvad

552 mm	Gråjärn DN 500
552-558 mm	AG-Rör
560 mm	PVG-Rör
560 mm	Polyetenrör
570 mm	AG-Rör PN 10/svarvad
572-580 mm	AG-Rör
580 mm	Gråjärn DN 500
606 mm	Stålrör DN 600
607 mm	Gråjärn DN 600
609,6 mm	Stålrör DN 600
630 mm	PVC-Rör
630 mm	Polyetenrör
632 mm	Gråjärn DN 600
635 mm	Segjärn DN 600
658 mm	Gråjärn DN 600
660 mm	AG Rör PN 7,5/svarvad
684 mm	AG-Rör PN 10/svarvad

TEKNISK INFORMATION

Bygglängder och höjder över centrumlinjen:

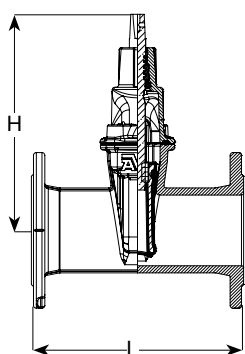

DN	Ventiler			Ventiler	
	Bygglängd enligt DIN F4 (EN 558-F14)	Bygglängd enligt DIN F5 (EN 558-F15)	Höjd över centrumlinjen	Bygglängd enligt BS (BS 5163)	Höjd över centrumlinjen
	L mm	L mm	H mm	L mm	H mm
25	-	120	180	-	-
32	-	140	190	-	-
40	140	240	241	-	-
50	150	250	241	178	279
65	170	270	271	190	279
80	180	280	297	203	294
100	190	300	334	229	324
125	200	325	376	254	324
150	210	350	448	267	429
200	230	400	562	292	531
250	250	450	664	330	614
300	270	500	740	356	690
350	290	550	940/930	381	867
400	310	600	940/960	406	867
450	330	650	951*/1170**/1130***	-	-
500	350	700	951*/1140**/1130***	-	-
600	390	800	- /1280**/1270***	-	-
700	430	-	1622	-	-
800	470	1000	1672**/1591***	-	-
900	510	-	2118	-	-
1000	550	-	2067	-	-

*Serie 02, ** serie 06, *** serie 55

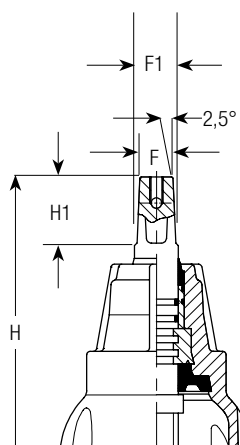

Spindelns dimensioner och höjder över centrumlinjen:

DN	Servisventiler				Ventiler enligt DIN F4 (EN 558-F14)			Ventiler enligt BS (BS 5163)		
	H mm	H1 mm	F mm	F1 mm	H1 mm	F mm	F1 mm	H1 mm	F mm	F1 mm
25	180	35	12,3	15,4	-	-	-	-	-	-
32	190	35	12,3	15,4	-	-	-	-	-	-
40	203	35	12,3	15,4	29	14	16,6	-	-	-
50	213	35	12,3	15,4	29	14	16,6	38	19	22,4
65	-	-	-	-	34	17	20	38	19	22,4
80	-	-	-	-	34	17	20	38	19	22,4
100	-	-	-	-	38	19	22,4	38	19	22,4
125	-	-	-	-	38	19	22,4	38	19	22,4
150	-	-	-	-	38	19	22,4	42	24	27,7
200	-	-	-	-	42	24	27,7	47	27	31,2
250	-	-	-	-	47	27	31,2	47	27	31,2
300	-	-	-	-	47	27	31,2	47	27	31,2
350	-	-	-	-	55	32	36,9	55	32	36,9
400	-	-	-	-	55	32	36,9	55	32	36,9
450*	-	-	-	-	55	32	36,9	-	-	-
500*	-	-	-	-	55	32	36,9	-	-	-
450**	-	-	-	-	84	Ø30	Ø30	-	-	-
500**	-	-	-	-	84	Ø30	Ø30	-	-	-
600**	-	-	-	-	84	Ø30	Ø30	-	-	-
700	-	-	-	-	83,5	Ø40	Ø40	-	-	-
800	-	-	-	-	83,5	Ø40	Ø40	-	-	-
900	-	-	-	-	83,5	Ø40	Ø40	-	-	-
1000	-	-	-	-	83,5	Ø40	Ø40	-	-	-

*serie 02 och 20 **serie 06

Flänstabel

Flänsborring enligt ISO 7005 del 2 (EN 1092-2: 1997, DIN 2501)

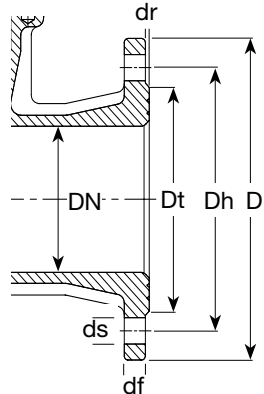

DN	D mm		Dt mm	Dh mm		df mm	dr mm	ds mm		Antal hål		Bult- storlek	
	PN10	PN16		PN 10	PN 16			PN 10	PN 16	PN 10	PN 16	PN 10	PN 16
40	150		83	110		16	3	19		4		M16	
50	165		102	125		16	3	19		4		M16	
65	185		122	145		16	3	19		4		M16	
80	200		138	160		16	3	19		8		M16	
100	220		158	180		16	3	19		8		M16	
125	250		188	210		16	3	19		8		M16	
150	285		212	240		16	3	23		8		M20	
200	340		268	295	295	17	3	23	23	8	12	M20	M20
250	400		320	350	355	19	3	23	28	12	12	M20	M24
300	455		370	400	410	21	4	23	28	12	12	M20	M24
350	520		430	460	470	23	4	23	28	16	16	M20	M24
400	580		482	515	525	28	4	28	31	16	16	M24	M27
450	640		535	565	585	28	4	28	31	20	20	M24	M27
500	715		590	620	650	28	4	28	34	20	20	M24	M30
600	840		685/725*	725	770	29	5	34	37	20	20	M27	M33
700	895	-	794	840	-	33	-	5	31	-	-	M27	-
800	1015	-	901	950	-	35	5	34	-	24	-	M30	-
900	1115	1125	1001	1050	1050	38	46	5	34	41	28	M30	M36
1000	1230	1255	1112	1160	1170	40	50	5	37	44	28	M33	M39

*Serie 55/30 / serie 06

Vridmoment och antal varv för att öppna ventilen

DN	Servisventiler serie 03 (Segjärn) serie 16 (Mässing)			Servisventiler POM				Slussventiler EN1074-1 och 2 / EN1171, Type A				
	Stänga Nm	Brottgräns Nm	Antal varv	Stänga Nm	Brottgräns		Antal varv	Stänga Nm	Vatten		Brottgräns Nm	Antal varv
					vid öppning Nm	vid stängning Nm			Moment Nm	Moment Nm		
25	35	200	7	20	100	200	7					
32	35	200	9	20	100	200	9					
40	35	200	11	40	100	200	11	25	3	9	250	12
50	35	200	14	40	100	200	14	25	3	9	250	12
65	-	-	-	-	-	-	-	25	3	9	250	17
80	-	-	-	-	-	-	-	35	3	9	400	17
100	-	-	-	-	-	-	-	35	3	9	400	21
125	-	-	-	-	-	-	-	40	3	9	500	26
150	-	-	-	-	-	-	-	40	3	18	600	26
200	-	-	-	-	-	-	-	80	3	18	800	33/35 ³⁾
250	-	-	-	-	-	-	-	180	12	18	1000	37
300	-	-	-	-	-	-	-	200	16	18	1200	44
350	-	-	-	-	-	-	-	300	24	24	1400	59
400	-	-	-	-	-	-	-	300	24	24	1600	59/50 ⁴⁾
450	-	-	-	-	-	-	-	300 ^{1)/450^{2)/500³⁾}}	25	25	1600	59 ^{1)/43^{2)/39³⁾}}
500	-	-	-	-	-	-	-	300 ^{1)/300^{2)/500³⁾}}	25	25	1600	59 ^{1)/43^{2)/43³⁾}}
600	-	-	-	-	-	-	-	500 ^{2)/500³⁾}	25	25	1600	53 ^{1)/52^{2)/53³⁾}}
700	-	-	-	-	-	-	-	850	60	-	1700	60
800	-	-	-	-	-	-	-	850	60	-	1700	70
10 bar/16 bar												
900								800/1100	300	-	2500	85
1000								800/1100	300	-	2500	85

¹⁾serie 02 och 20

²⁾serie 06 och 26

³⁾serie 55

⁴⁾serie 36

⁵⁾serie 15

GUMMI

SPECIFIKATIONER

Gummikvalité Gummityp	EUW-70 EPDM	EUW-75 EPDM	EUW-80 EPDM	EAW-70 EPDM	EAW-75 EPDM	EDK-55 EPDM	EDK-70 EPDM	EDK-80 EPDM
Hårdhet (ShA)	70	76	80	70	76	56	70	80
Draghållfasthet (Mpa)	14.0	15.0	13.0	12.0	10.1	10.0	13.0	13.0
Brottöjning (%)	370	353	350	400	361	500	300	290
Densitet (g/cm ³)	1.10	1.18	1.21	1.23	1.31	1.19	1.12	1.17

Temperaturområde i torr atmosfärisk luft:

Minimitemperatur (°C) *	-40	-40	-40	-40	-40	-40	-40	-40
Maximal temperatur (°C) *	+120	+120	+120	+120	+120	+120	+120	+120

Kompression DIN 53517, 24 h / 70 °C (%)	15.0	12.0	15.0	15.0	12.5	12.0	8.0	17.0
---	------	------	------	------	------	------	-----	------

Egenskaper:

Slitstyrka	3	3	3	2	2	2	3	3
Rivhållfasthet	4	4	4	3	3	2	3	3
Beständighet mot väder och ozon	4	4	4	4	4	4	4	4
Beständighet mot hydrolys (vatten och ånga)	4	4	4	4	4	4	4	4
Resistens mot kemikalier (syror / baser)	3	3	3	3	3	3	3	3
Beständighet mot olja och gas	0	0	0	0	0	0	0	0
Genomtränglighet	1	1	1	1	1	1	1	1

0: Låg 1: Begränsad 2: Mellan 3: Betydande 4: Hög

Gummikvalité Gummityp	NDG-80 NBR	NGW-70 NBR	SAK-70 SBR
Hårdhet (ShA)	80	70	70
Draghållfasthet (Mpa)	18.0	15.0	15.0
Brottöjning (%)	220	320	300
Densitet (g/cm ³)	1.26	1.23	1.17

Temperaturområde i torr atmosfärisk luft:

Minimitemperatur (°C) *	-35	-40	-50
Maximal temperatur (°C) *	+110	+110	+100

Kompression DIN 53517, 24 h / 70°C (%)	8.0	8.0	13.0
--	-----	-----	------

Egenskaper:

Slitstyrka	3	3	4
Rivhållfasthet	3	3	3
Beständighet mot väder och ozon	3	3	3
Beständighet mot hydrolys (vatten och ånga)	3	3	3
Resistens mot kemikalier (syror / baser)	2-3	2-3	2
Beständighet mot olja och gas	4	4	0
Genomtränglighet	4	4	2

0: Låg 1: Begränsad 2: Mellan 3: Betydande 4: Hög

Godkännanden / anmärkningar:

EUW-70: KTW D1/D2, W270, WRAS (60°C), ACS XP P 41-250, AS/NZS 4020, NSF-61, EN 681-1, AS 1646-2007, Önorm B5014

EUW-75: KTW D1/D2, W270, WRAS (50°C), ACS XP P 41-250, EN 681-1

EUW-80: KTW D1/D2, W270, WRAS, ACS XP P 41-250, EN 681-1

EAW-70: KTW D1/D2 (varm 60°C), W270

EAW-75: KTW D1/D2, W270

EDK-55: ACS XP P41-250

EDK-70: KTW D1/D2 (60°C), ACS XP P 41-250, CSN 75 7111, NBN S 29003, Hydrochek

EDK-80: KTW D1/D2

NGW-70: EN 682 typ GBL, KTW D2

SAK-70: UL-listad 22 06 1993

Ovanstående resultat är baserade på laboratorietester och måste utvärderas för specifika artiklar och program

Brand kan skapa små mängder vätesulfid och koldioxid. Avfallshantering genom förbränning ska ske i enlighet med lokala föreskrifter

*) Olika temperaturbegränsningar för ventiler kan gälla på grund av bindningen mellan metall och gummi



CERTIFIKAT



MANAGEMENT SYSTEM CERTIFICATE

Certificate no.: 05030-1998-AQ-DEN-DANAK Initial certification date: 24 August 1990 Valid: 01 April 2021 – 31 March 2024

This is to certify that the management system of
AVK International A/S
Bizonvej 1, 8464 Galten, Denmark
and the sites as mentioned in the appendix accompanying this certificate

has been found to conform to the Quality Management System standard:
ISO 9001:2015

This certificate is valid for the following scope:
Production of Valves and Valve Accessories. Marketing and Sales of Valves and Valve Accessories

Place and date:
Hellerup, 18 March 2021



For the issuing office:
DNV - Business Assurance
Tuborg Parkvej 8, 2. 2900 Hellerup, Denmark

Jesper Schultz
Management Representative

Lack of fulfillment of conditions as set out in the Certification Agreement may render this Certificate invalid.
ACCREDITED UNIT: DNV GL Business Assurance Denmark A/S, Tuborg Parkvej 8, DK-2900 Hellerup, Denmark - TEL: +45 39 45 48 00. <http://assurance.dnvgl.com>



Certificate no.: 05030-1998-AQ-DEN-DANAK
Place and date: Hellerup, 18 March 2021

Appendix to Certificate

AVK International A/S

Locations included in the certification are as follows:

Site Name	Site Address	Site Scope
AVK International A/S	Ursusvej 15A, 8464 Galten, Denmark	Production of Valves and Valve Accessories.
AVK International A/S	Ursusvej 15B, 8464 Galten, Denmark	Production of Valves and Valve Accessories.
AVK International A/S	Smedeskovvej 40-42, 8464 Galten, Denmark	Warehouse operations and Production of Valves and Valve Accessories.
AVK International A/S	Bizonvej 1, 8464 Galten, Denmark	Management, Marketing and Sales of Valves and Valve Accessories. Warehouse operations

Lack of fulfillment of conditions as set out in the Certification Agreement may render this Certificate invalid.
ACCREDITED UNIT: DNV GL Business Assurance Denmark A/S, Tuborg Parkvej 8, DK-2900 Hellerup, Denmark - TEL: +45 39 45 48 00. <http://assurance.dnvgl.com>



MANAGEMENT SYSTEM CERTIFICATE

Certificate no.: 05980-2003-AE-DEN-DANAK Initial certification date: 01 May 2003 Valid: 01 April 2021 – 31 March 2024

This is to certify that the management system of
AVK International A/S
Bizonvej 1, 8464 Galten, Denmark
and the sites as mentioned in the appendix accompanying this certificate

has been found to conform to the Environmental Management System standard:
ISO 14001:2015

This certificate is valid for the following scope:
Production of Valves and Valve Accessories. Marketing and Sales of Valves and Valve Accessories

Place and date:
Hellerup, 18 March 2021



For the issuing office:
DNV - Business Assurance
Tuborg Parkvej 8, 2, 2900 Hellerup, Denmark

Jesper Schultz
Management Representative

Lack of fulfillment of conditions as set out in the Certification Agreement may render this Certificate invalid.
ACCREDITED UNIT: DNV GL Business Assurance Denmark A/S, Tuborg Parkvej 8, DK-2900 Hellerup, Denmark - TEL: +45 39 45 48 00. <http://assurance.dnvgi.com>



Certificate no.: 05980-2003-AE-DEN-DANAK
Place and date: Hellerup, 18 March 2021

Appendix to Certificate

AVK International A/S

Locations included in the certification are as follows:

Site Name	Site Address	Site Scope
AVK International A/S	Ursusvej 15A, 8464 Galten, Denmark	Production of Valves and Valve Accessories.
AVK International A/S	Ursusvej 15B, 8464 Galten, Denmark	Production of Valves and Valve Accessories.
AVK International A/S	Smedeskovvej 40-42, 8464 Galten, Denmark	Warehouse operations and Production of Valves and Valve Accessories.
AVK International A/S	Bizonvej 1, 8464 Galten, Denmark	Management, Marketing and Sales of Valves and Valve Accessories. Warehouse operations

Lack of fulfillment of conditions as set out in the Certification Agreement may render this Certificate invalid.
ACCREDITED UNIT: DNV GL Business Assurance Denmark A/S, Tuborg Parkvej 8, DK-2900 Hellerup, Denmark - TEL: +45 39 45 48 00. <http://assurance.dnvgi.com>

CERTIFIKAT



MANAGEMENT SYSTEM CERTIFICATE

Certificate no.:
260995-2018-Q-DEN-DNV

Initial certification date:
26 April 2018

Valid:
01 April 2021 – 31 March 2024

This is to certify that the management system of
AVK International A/S
Bizonvej 1, 8464 Galten, Denmark
and the sites as mentioned in the appendix accompanying this certificate

has been found to conform to the Quality Management System standard:
ISO/TS 29001:2010

This certificate is valid for the following scope:
Production of Valves and Valve Accessories. Marketing and Sales of Valves and Valve Accessories

Place and date:
Hellerup, 18 March 2021



For the issuing office:
DNV - Business Assurance
Tuborg Parkvej 5, 2., 2900 Hellerup, Denmark

Jesper Schultz
Management Representative

Lack of fulfillment of conditions as set out in the Certification Agreement may render this Certificate invalid.
CERTIFYING UNIT: DNV Business Assurance Norway AS, Veritasveien 1, 1363 Høvik, Norway
TEL: +47 67 57 99 00. www.dnvgl.com/assurance



Certificate no.: 260995-2018-Q-DEN-DNV
Place and date: Hellerup, 18 March 2021

Appendix to Certificate

AVK International A/S

Locations included in the certification are as follows:

Site Name	Site Address	Site Scope
AVK International A/S	Ursusvej 15A, 8464 Galten, Denmark	Production of Valves and Valve Accessories.
AVK International A/S	Ursusvej 15B, 8464 Galten, Denmark	Production of Valves and Valve Accessories.
AVK International A/S	Smedskovvej 40-42, 8464 Galten, Denmark	Warehouse operations and Production of Valves and Valve Accessories.
AVK International A/S	Bizonvej 1, 8464 Galten, Denmark	Management, Marketing and Sales of Valves and Valve Accessories. Warehouse operations

Lack of fulfillment of conditions as set out in the Certification Agreement may render this Certificate invalid.
CERTIFYING UNIT: DNV Business Assurance Norway AS, Veritasveien 1, 1363 Høvik, Norway
TEL: +47 67 57 99 00. www.dnvgl.com/assurance



MANAGEMENT SYSTEM CERTIFICATE

Certificate no.: 05982-2003-AHSO-DEN-DANAK Initial certification date: 01 May 2003 Valid: 01 April 2021 – 31 March 2024

This is to certify that the management system of
AVK International A/S
Bizonvej 1, 8464 Galten, Denmark
P.no.: 1013803974
and the sites as mentioned in the appendix accompanying this certificate

has been found to conform to the Occupational Health and Safety Management System s
DS/ISO 45001:2018
& Executive Order no. 1409 of 26.09.2020

This certificate is valid for the following scope:
**Production of Valves and Valve Accessories.
Marketing and Sales of Valves and Valve Accessories**

Place and date:
Hellerup, 18 March 2021



For the issuing office:
DNV - Business Assurance
Tuborg Parkvej 8, 2., 2900 Hellerup, D

Jesper Schultz
Management Representative

Lack of fulfillment of conditions as set out in the Certification Agreement may render this Certificate invalid.
ACCREDITED UNIT: DNV GL Business Assurance Denmark A/S, Tuborg Parkvej 8, DK-2900 Hellerup, Denmark - TEL: +45 39 45 48 00. <http://assurance.dnvgi.com>



Certificate no.: 05982-2003-AHSO-DEN-DANAK
Place and date: Hellerup, 18 March 2021

Appendix to Certificate

AVK International A/S

Locations included in the certification are as follows:

Site Name	Site Address	P-Number	Site Scope
AVK International A/S	Ursusvej 15A, 8464 Galten, Denmark	1003196871	Production of Valves and Valve Accessories.
AVK International A/S	Ursusvej 15B, 8464 Galten, Denmark	1003196871	Production of Valves and Valve Accessories.
AVK International A/S	Smedeskovvej 40-42, 8464 Galten, Denmark	1003196858	Warehouse operations and Production of Valves and Valve Accessories.
AVK International A/S	Bizonvej 1, 8464 Galten, Denmark	1013803974	Management, Marketing and Sales of Valves and Valve Accessories, Warehouse operations

Lack of fulfillment of conditions as set out in the Certification Agreement may render this Certificate invalid.
ACCREDITED UNIT: DNV GL Business Assurance Denmark A/S, Tuborg Parkvej 8, DK-2900 Hellerup, Denmark - TEL: +45 39 45 48 00. <http://assurance.dnvgi.com>
Page 2 of 2

CERTIFIKAT

Gütegemeinschaft Schwerer Korrosionsschutz | Quality Assurance Association for Heavy-Duty Corrosion Protection

AWARD CERTIFICATE
Production heavy corrosion protection of valves and fittings

The Quality Assurance Association for Heavy Duty Corrosion Protection of Valves and Fittings by Powder Coating e.V. (GSK) awards based on the test report of the externally supervising body presented to the Quality Committee and on the resolution of the Executive Committee of GSK for the coating procedure for the production of heavy corrosion protection for valves and fittings and for the product families mentioned in the appendix to the company:

AVK International A/S
Smedskovvej 40, 8464 Galten, DENMARK
Ursusvej 15, 8464 Galten, DENMARK

the right to use the quality mark with the performance-related addition RAL-GZ 662/2.

The quality mark is certified by the Institute for Quality Assurance and Certification e.V. (RAL) and protected by registration at the German Patent and Trademark Office as a collective trademark (EU trademark 009300138).

The products, which were manufactured according to the quality and test regulations (GPB) of the GSK, are designated as product families by the enterprise to the association's office and listed in the appendix and on the GSK homepage (www.gsk-online.de). They receive the following marking:

AWK

This certificate is valid until 31st December 2024

Schwäbisch Gmünd, the 31st December 2021

Managing Director

Not valid without annex
The product families must be listed in the certificate. The holder of the quality mark informs GSK about the inclusion of new products or changes to existing products in the product approval, and GSK in turn informs the testing institutes. The current list of product families manufactured in GSK quality can be found on the GSK website (www.gsk-online.de).

Gütegemeinschaft Schwerer Korrosionsschutz | Quality Assurance Association for Heavy-Duty Corrosion Protection

Annex to the certificate of 31st December 2021

The certificate of the company

AVK International A/S
Smedskovvej 40, 8464 Galten, DENMARK
Ursusvej 15, 8464 Galten, DENMARK

is valid for the following product families

No.	Product	Nominal size
1	Resilient seated gate valves series 01, 02, 06, 12, 15, 18, 32, 33, 36, 38, 43, 50, 55, 636, 638	DN 40 - 600
2	Butterfly valve series 756	DN 150 - 800
3	Universal coupling, Supa Maxi series 631, 632, 633, 634, 635	DN 040 - 800
4	Fittings, series 106 thread connection 1" - 2" and series 107	DN 025 - DN 050
5	Spacers, series 109	DN 080 - DN 400
6	Service connection valves, series 03/00, 03/30, 03/40, 03/65, 03/85, 03/90, 11/00, 11/30	DN 025 - 050
7	Service connection valves with PE-Pipe end, series 36/8x	DN 025 - 050
8	Tapping saddles, series 100	DN 050 - DN 200
9	Service connection valves, series 103	DN 032

Not valid without annex
The product families must be listed in the certificate. The holder of the quality mark informs GSK about the inclusion of new products or changes to existing products in the product approval, and GSK in turn informs the testing institutes. The current list of product families manufactured in GSK quality can be found on the GSK website (www.gsk-online.de).

Gütegemeinschaft Schwerer Korrosionsschutz | Quality Assurance Association for Heavy-Duty Corrosion Protection

AWARD CERTIFICATE
Production heavy corrosion protection of valves and fittings

The Quality Assurance Association for Heavy Duty Corrosion Protection of Valves and Fittings by Powder Coating e.V. (GSK) awards on the basis of the quality committee's present test report of the externally supervising body and the resolution of the board of GSK for the coating procedure for the production of heavy corrosion protection for valves and fittings and for the product families mentioned in the appendix, the company:

AVK Armaturen GmbH
Schillerstraße 50, 42489 Wülfrath

the right to use the quality mark with the performance-related addition RAL-GZ 662/2.

The quality mark is certified by the Institute for Quality Assurance and Labelling e.V. (RAL) and protected by registration at the German Patent and Trademark Office as a collective trademark (EU trademark 009300138).

The products, which were manufactured after the conditions of the quality and test regulations (GPB) of the GSK, are designated as product families by the enterprise of the office, and in the appendix and on the GSK homepage (www.gsk-online.de) listed. They receive the following marking:

AWK

This certificate is valid until 31st Dec. 2021

Schwäbisch Gmünd, the 31st December 2020

Managing Director

Not valid without annex
The product families must be listed in the certificate. The user of the quality mark informs GSK about the inclusion of new products or changes to existing products in the product approval, and GSK in turn informs the testing institutes. The current list of product families manufactured in GSK quality can be found on the GSK website (www.gsk-online.de).

Gütegemeinschaft Schwerer Korrosionsschutz | Quality Assurance Association for Heavy-Duty Corrosion Protection

Annex to the certificate of 31st December 2020

The certificate of the company

AVK Armaturen GmbH
Schillerstraße 50, 42489 Wülfrath

is valid for the following product families

Nr.	Product	nominal size
1	Series 35 Underground Hydrant L7 with the declaration inside and outside EKB	DN 80
2	Series 35 Underground Hydrant K7 with the declaration inside and outside EKB	DN 80
3	Series 29 Underground Hydrant F7	DN 80
4	Series 35 Underground Hydrant R7	DN 80
5	Series 35 Underground Hydrant RUHUUH	DN100 and DN 125
6	Series 84 Aboveground Hydrant P5 all with the declaration inside and outside EKB	DN 80 and DN 100
7	Series 84 Aboveground Hydrant P7 all with the declaration inside and outside EKB	DN 80 and DN100
8	Series 84 Aboveground Hydrant N7 all with the declaration inside and outside EKB	DN 80 and DN100
9	Series 27 Aboveground Hydrant	DN 100 and DN 150

Not valid without annex
The product families must be listed in the certificate. The user of the quality mark informs GSK about the inclusion of new products or changes to existing products in the product approval, and GSK in turn informs the testing institutes. The current list of product families manufactured in GSK quality can be found on the GSK website (www.gsk-online.de).



AVK Sverige AB
Växthusvägen 5
281 51 Hässleholm

Växel: 0451-458 00
Fax: 0451-458 05
E-post: sales@avkvalves.se
www.avkvalves.se

2022-01-01
Copyright©AVK Sverige AB 2022

Expect... **AVR**